

Precision Boring Bars | Mini-Inserts  
PCD, CVD-D, UltraDiamond, CBN

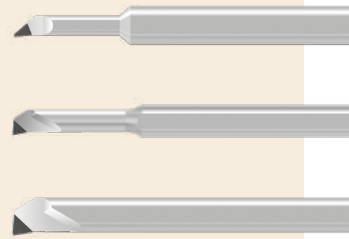

Die and Mold  
Industry



Automotive  
Mechanical Engineering

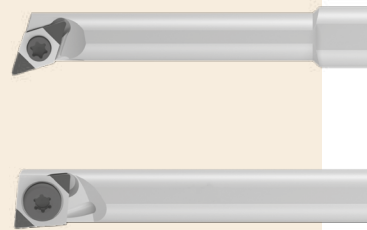

Medical Technology  
Micro Technology

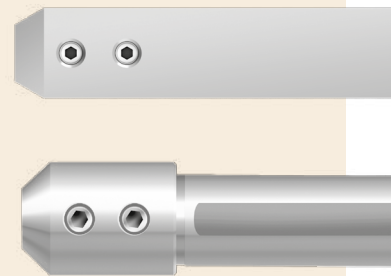

Aerospace  
Engineering

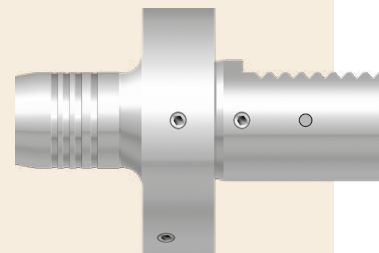

## About us

Diamond Tooling Systems - DTS GmbH



## Welcome to Diamond Tooling Systems GmbH - DTS GmbH!

Based in Kaiserslautern - Germany - we have specialized in the development, production and distribution of precision tools equipped with ultrahard cutting materials, such as PCD (polycrystalline diamond), CVD-D (CVD thickfilm diamond), UltraDiamond (monocrystalline binderless diamond) and CBN (cubic boron nitride). As a leading manufacturer for tools with lasered cutting edges, we offer machining solutions in the areas of turning, milling, grooving, drilling, reaming, threading, and tool holding.

To be able to economically process ultra-hard cutting materials such as PCD, CVD-D and CBN on precision tools we realized early on that we would have to move away from the traditional production technology of „grinding“ to new technologies such as the „laser removal process“. This decision has contributed to the fact that our customers regard us, DTS GmbH, as the pioneer and leading manufacturer of lasered tools for machining.

Ultra-hard high-performance cutting materials have a key function in metal-cutting manufacturing. Precision tools equipped with ultra-hard cutting materials are products that require a great deal of explanation. The economical use of the cutting materials is only ensured if the machining process and the cutting material are coordinated with each other.

This is exactly where we at DTS - Diamond Tooling Systems GmbH - step in: Tools and processes are subjected to a comprehensive analysis by our experienced application engineers. Subsequently, the new process optimization is presented to the customer and in the next step, it is implemented in their production. Only in that way is it possible to exploit the optimum potential of our high-tech cutting materials.

Our experienced application engineers are also available to advise you during ongoing production. This close cooperation and mutual trust is the basis of our success.

**With more than 25 years of optimization experience in the processing industry, this is where we see our strength!**

## Contents

Precision Boring Tools

### Overview

Ultrahard Cutting Materials at a Glance	04
Our Cutting Materials PCD, CVD-D, UltraDiamond and CBN at a Glance	06
Application examples - our Cutting Edge in at a Glance	07
Our Cutting Material Assignment	08

### Products

#### Brazed Boring Tools

Our Boring Tools at a Glance	10
Possible applications of our Boring Tools	11
Precision Boring Tools - Typ BS	12
Precision Boring Tools - Typ BE	16

#### MiniTools

ISO Code	18
MiniTools, CVD-D, UltraDiamond and CBN Inserts	19
MT... SCLDR/L 95° / 5°	21
MT... SDQCR/L 107,5° / 17,5°	24
MT... SDUCR/L 93° / 32°	25
MT... SELPR/L 95° / 10°	26
MT... SRLCR/L 95° / 10°	27
MT... STXPR/L 62,5° / 57,5°	28
MT... SVXCR/L 5° / 140°	29
MT... SVXCR/L 113° / 32°	30
MT... SVLCR/L 95° / 50°	31
MT... SVVCR 72,5° / 72,5°	32
MT... SVXCR/L 50° / 95°	33
MT... SWUCR/L 93° / 7°	34

#### Spannsysteme

Hydraulic Chuck	36
Clamping adapter	39

### Technical Attachment

Cutting Parameters	42
Formulas	46
Copyright and Safety Instruction	51



You can also get all of our products via our online shop - anytime, fast and easy.  
[www.diamond-tools24.com](http://www.diamond-tools24.com)

## PASSION FOR DIAMOND...

Ultrahard Cutting Materials at a Glance

... is not just a slogan for us - we live this passion in our daily dealings with our customers and we are your partner when it comes to Diamond or CBN tools.

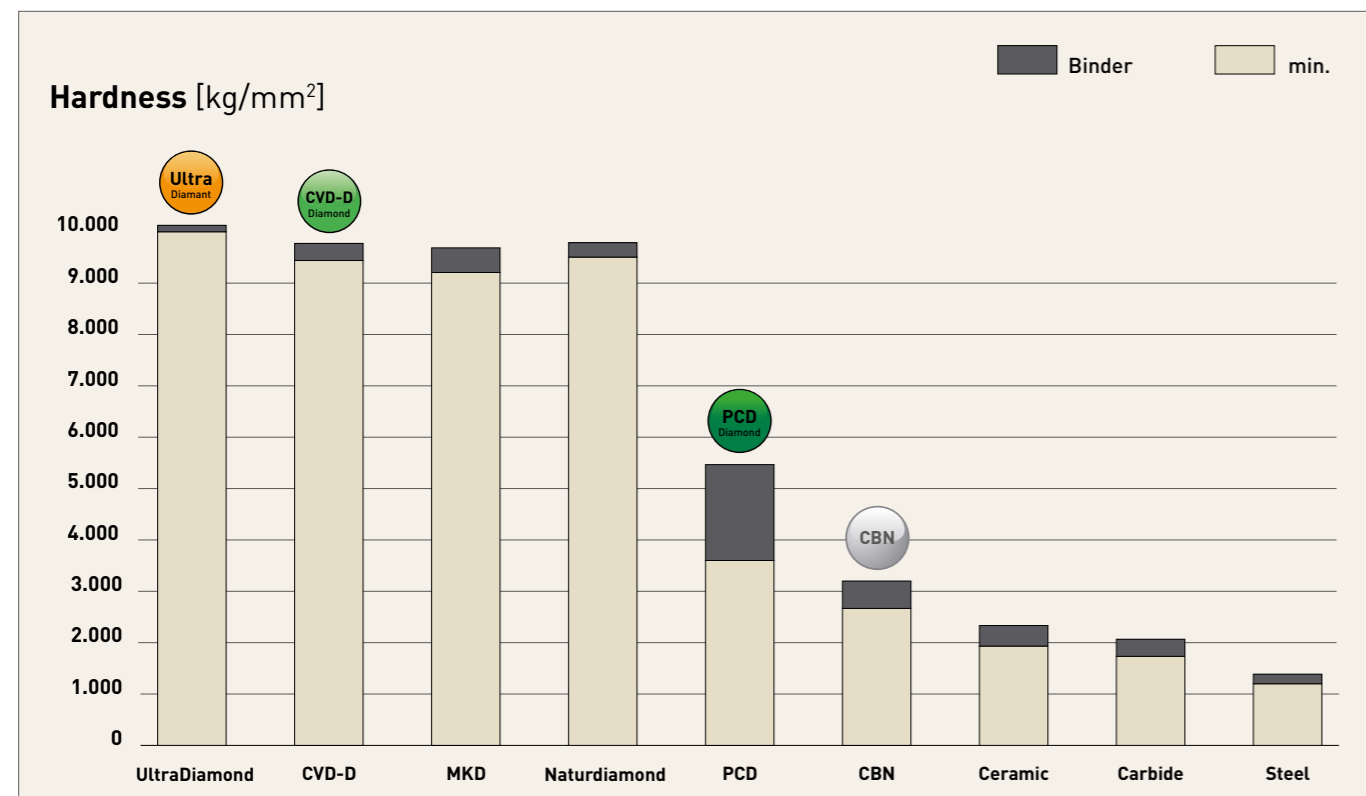

### Polycrystalline Diamond (PCD)

The well-known standard Diamond

PCD is a synthetically produced, extremely tough, intergrown mass of Diamond particles with random orientation in a Metal matrix. It is produced by sintering selected Diamond particles at high pressure and high temperatures.

Graphite is used as a catalyst so that the PCD crystals grow together. PCD has high thermal conductivity and good heat dissipation from the cutting area. In addition, PCD has the highest bending strength of all cutting materials bending strength of all cutting materials.

PCD is very well suited for machining aluminium with a Si content of up to 10% and/or other abrasive fillers. The hot hardness is approx. 750°C, the areas of application are similar to those of CVD thick film Diamond, but the high efficiency of CVD thick film Diamond comes into its own with hard-brittle materials or aluminium with a Si content of 10% or more.

### CVD thick film Diamond (CVD-D)

The star among Diamond Cutting Materials

For machining hard-brittle materials such as ceramics, glass, glass-ceramics, hard Metal, MMC and fibre composites such as CFK and GFK. Due to the lack of a bonding matrix, the Diamond content is much higher than with PCD. In the group of ultra-hard cutting materials, the binderless CVD-D is one of the hardest, artificially produced Diamond cutting materials.

CVD-D is characterised by high hardness and high wear resistance. These properties make CVD-D the perfect cutting material for machining abrasive materials. Compared to PCD, which is damaged by the abrasive particles due to its soft metallic binder phase, the CVD-D cutting edge remains stable due to its binderless anchoring in the Diamond matrix.

If CVD-D is used correctly, the service life can be increased by up to 10 times (and even more) compared to PCD!

### Binderless Diamond (UltraDiamond)

The hardest single Crystal

Single-crystal elements are laser-cut from Diamond blanks in a defined orientation using laser segmentation technology. This new technology makes it possible, in addition to polycrystalline cutting materials such as PCD and CVD-D, to also braze a monocrystal (UltraDiamond) under high vacuum on any tool carrier. Compared to PCD, the tool life can be increased by approx. 15 to 25 times and compared to CVD-D by approx. 2 to 5 times.

The areas of application are similar to PCD and CVD-D, but this monocrystalline cutting material offers a further significant increase in tool life in all applications where PCD and CVD-D reach the limits of economic viability. The UltraDiamond cutting material makes economical machining of very hard, highly brittle materials such as Ceramics, glass, glass-Ceramics and hard metals with low cobalt binder and nickel binder (<10%) possible. Ceramics, glass, glass-ceramics and hard metals with low cobalt binder and nickel binder (<10%).

### Polycrystalline Cubic Boron Nitride (CBN)

Chemically resistant and stable at high temperatures

CBN is stable up to 1,400°C. Boron nitride powder is the starting point for the production of CBN, which has been available since the late 1960s. It is produced under high pressure as well as at temperatures of over 1,500°C and is specially adapted to the final application through many different substrates.

Today, CBN is considered the second hardest material after Diamond cutting materials!

The applications of CBN are in the automotive industry, aerospace, tool and mould making and mechanical engineering. The wide spectrum as a cutting and abrasive material includes hardened Steels, Cast Iron, chilled Cast Iron, sintered materials, stellite, nickel and cobalt-based superalloys. In many applications, cubic boron nitride is preferred over Diamond cutting materials because it is absolutely stable in air at temperatures up to 1,400°C. Diamond, on the other hand, starts to decompose at a temperature of about 750°C.

Compared to PCD, CBN is also characterised by its chemical resistance to ferrous materials.



# Our cutting materials

and their main areas of application at a glance

Our wide range of cutting materials allows us to offer the ideal solution for your applications.

Below you will find an overview of the different cutting materials.

**PCD**  
Diamond

**PCD Diamond**

is ideally suited for the machining of\*

Aluminium <10% Si | Brass | Ceramic green compact | Copper | Copper Alloy | Graphite | Magnesium | PEEK | Tungsten Alloy

**CVD-D**  
Diamond

**CVD-D Diamond**

is ideally suited for the machining of\*

Acrylic (PMMA) | Aluminium >10% Si | Carbide >10%Co | Ceramic | Copper, Copper Alloys | Composites (CFRP, GFRP) | Glass, GlassCeramic | Magnesium | Plastics | Silver, Gold, Platinum | Titanium | Zirconium

**Ultra**  
Diamond

**UltraDiamond**

is ideally suited for the cutting of\*

Acryl (PMMA) | Carbide <12%Co | Ceramic | Glas, GlasCeramic

**CBN-H**

is ideally suited for the machining of\*

Steels, hardened up to 72 HRC  
Sintered steels, hardened

continuous cut

light interrupted cut

heavy interrupted cut

**CBN-K**

is ideally suited for the machining of\*

Grey cast iron (GG)  
Ductile cast iron (GGG)

continuous cut

light interrupted cut

heavy interrupted cut

**CBN-X**

is ideally suited for the machining of\*

HSS, Tool steel  
ASP, CPM and other PM steels  
Cold and Hot work steels  
Solid carbide steel joints

continuous cut

light interrupted cut

heavy interrupted cut

\*all other applications can be found in the complete cutting material assignment from page 8

# Application examples

our cutting edges in use

Not only theory - we would like to show you our tools in action. Below you will find a selection of our CBN application videos. Click on the QR code for more information and the video.

Also visit our YouTube Channel at [dts-gmbh!](https://www.youtube.com/dts-gmbh)

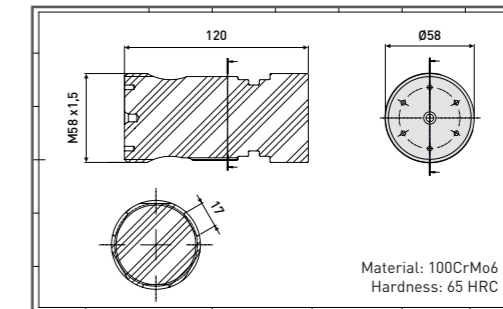

**Hard spindles**  
100CrMo6 65 HRC  
Brazen boring bar

Here you  
can see  
the video!

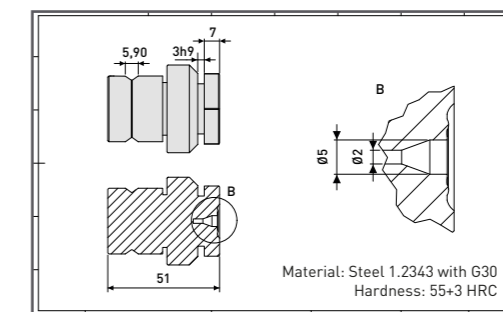
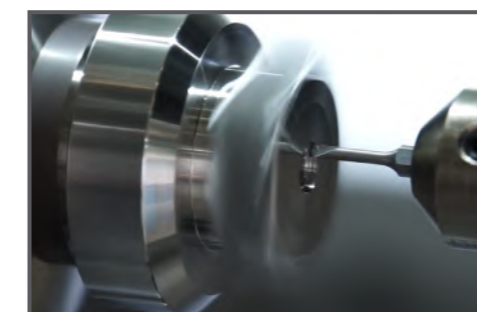

**Internal boring**  
Carbide G30  
Brazen boring bar

Here you  
can see  
the video!

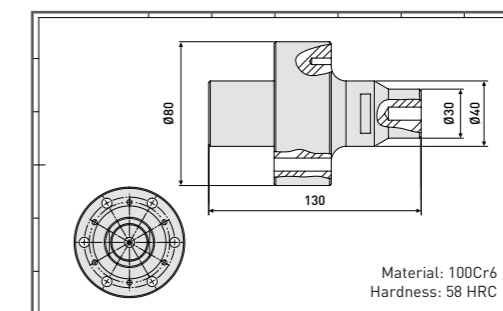

**Internal boring**  
100Cr6 58 HRC  
MiniTool mit CDGW 040102

Here you  
can see  
the video!

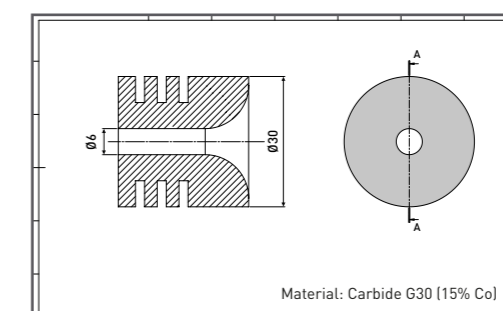

**Internal boring**  
Carbide G30 (15% Co)  
MiniTool mit CDGW 040202

Here you  
can see  
the video!

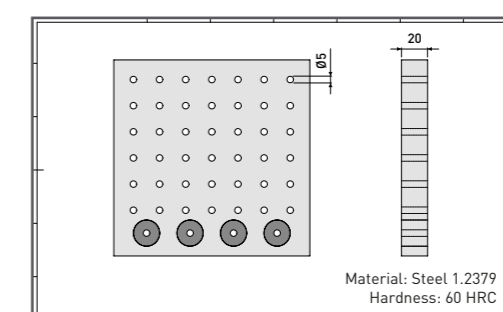

**Internal boring**  
Steel 1.2379 60+2 HRC  
MiniTool mit CDGW 040102

Here you  
can see  
the video!



## Our Boring Tools at a Glance

for bore machining and spindling

For the machining on turning and milling centers we offer you two systems for boring starting from  $\varnothing 1,00\text{mm}$ .

You can choose between soldered tools and a system with carbide boring bars and indexable inserts.

### Brazed Precision Boring Tools

from Page 12

starting from  $\varnothing 1,00\text{mm}$

- ✓ Corner Radius 0,10 - 0,40mm
- ✓ Carbide Shank
- ✓ Up to four machining depths per  $\varnothing$  for optimum rigidity
- ✓ Easy alignment due to adjustment bevel and clamping surface

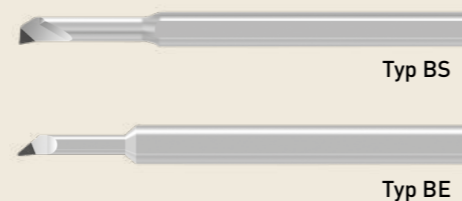

Typ BS

Typ BE

### MiniTools – with multi-edged Inserts

from Page 21

starting from  $\varnothing 3,50\text{mm}$

- ✓ Corner Radius 0,10 - 0,40mm
- ✓ Low Vibration Carbide Design
- ✓ High efficiency due to multi-edged inserts
- ✓ Easy alignment due to adjustment bevel and clamping surface

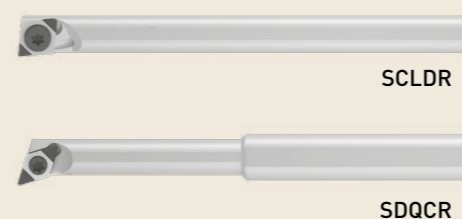

SCLDR

SDQCR



### Matching Clamping Adapters

from Page 36

- ✓ Boring Bar adjustable in length
- ✓ Exact positioning of the cutting edge



Cooling through the clamping surface of the tool possible for all holders.

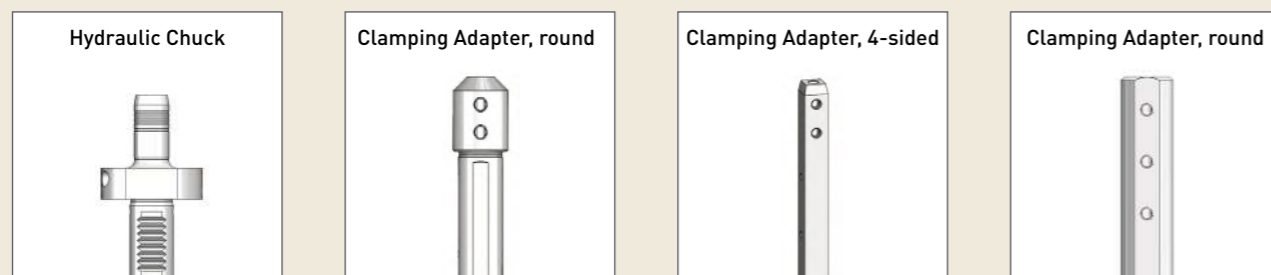

## Application Possibilities

of our Precision Boring Tools

To adapt our boring tools perfectly to your application, we have two different types in our standard program. These enable you to use ultra hard cutting materials to reliably machine cylindrical and conical surfaces with radial transitions as well as flat surfaces.

### Typ BS

starting from  $\varnothing 1,00\text{mm}$

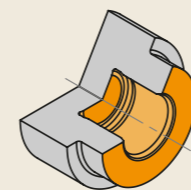

all colored surfaces can be machined

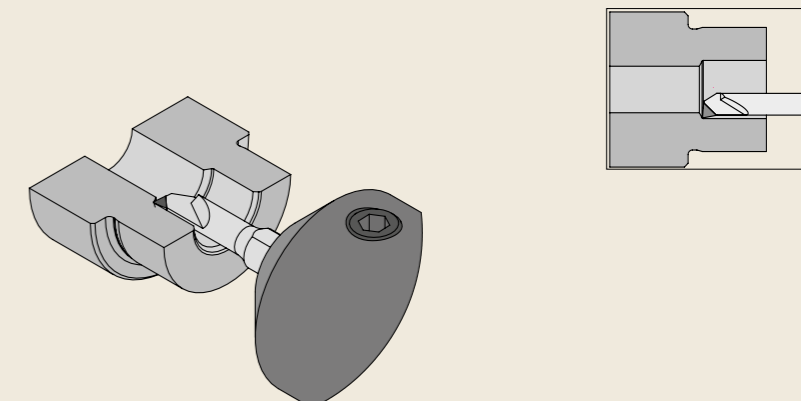

Robust system for turning contours in bores.

### Type BE

starting from  $\varnothing 3,60\text{mm}$

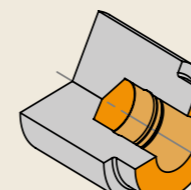

all colored surfaces can be machined

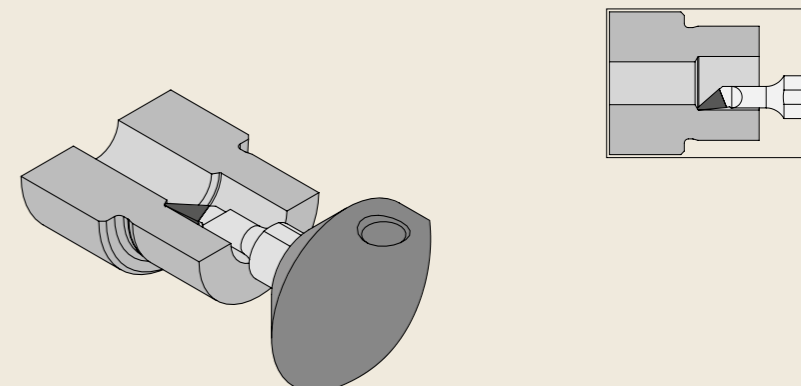

For contour turning on the plane surface.

# Precision boring bars

brazed cutting edge for internal machining from Ø 1,00 mm

## Typ BS

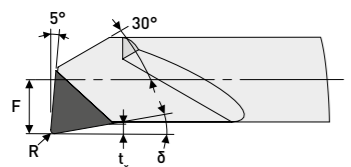
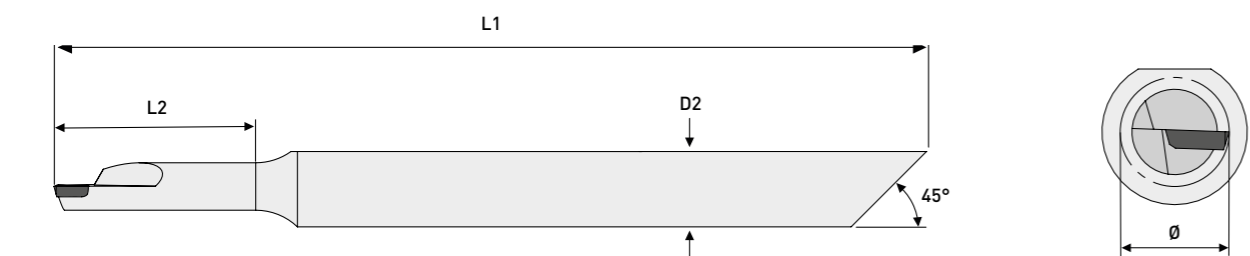

Picture shows right version

Ø	F	L2	L1	R	D2	t <sub>x</sub>	δ	Version	Material			
									Item No.	Item No.	Item No.	
1,00	0,50	3,00	72,00	0,10	4h6	0,05	3°	right		BS2050-1002	BS3550-1002	
								left		BS2050-1003	BS3550-1003	
	0,50	10,00	80,00	0,10	4h6	0,05	3°	right	BS1050-0000	BS2050-0000	BS3550-0000	
								left	BS1050-0001	BS2050-0001	BS3550-0001	
	1,50	0,75	3,00	71,00	0,10	4h6	0,15	3°	right		BS2050-1007	BS3550-1007
									left		BS2050-1008	BS3550-1008
0,75		6,00	74,00	0,10	4h6	0,15	3°	right		BS2050-1005	BS3550-1005	
								left		BS2050-1006	BS3550-1006	
2,00	0,75	15,00	80,00	0,10	4h6	0,15	3°	right	BS1050-0005	BS2050-0005	BS3550-0005	
								left	BS1050-0006	BS2050-0006	BS3550-0006	
	1,00	6,00	74,00	0,10	4h6	0,17	3°	right		BS2050-1012	BS3550-1012	
								left		BS2050-1013	BS3550-1013	
	1,00	6,00	74,00	0,20	4h6	0,17	3°	right		BS2050-2012	BS3550-2012	
								left		BS2050-2013	BS3550-2013	
1,00	10,00	80,00	0,10	4h6	0,17	3°	right	BS1050-0010	BS2050-0010	BS3550-0010		
							left	BS1050-0011	BS2050-0011	BS3550-0011		

Ø	F	L2	L1	R	D2	t <sub>x</sub>	δ	Version	Material		
									Item No.	Item No.	Item No.
2,50	1,25	6,00	74,00	0,10	4h6	0,25	10°	right		BS2050-1022	BS3550-1022
								left		BS2050-1023	BS3550-1023
	1,25	6,00	74,00	0,20	4h6	0,25	10°	right		BS2050-2022	BS3550-2022
								left		BS2050-2023	BS3550-2023
	1,25	10,00	80,00	0,10	4h6	0,25	10°	right	BS1050-0020	BS2050-0020	BS3550-0020
								left	BS1050-0021	BS2050-0021	BS3550-0021
3,00	1,50	6,00	74,00	0,10	4h6	0,33	10°	right		BS2050-1028	BS3550-1028
								left		BS2050-1029	BS3550-1029
	1,50	6,00	74,00	0,20	4h6	0,33	10°	right		BS2050-2028	BS3550-2028
								left		BS2050-2029	BS3550-2029
	1,50	10,00	78,00	0,10	4h6	0,33	10°	right		BS2050-1026	BS3550-1026
								left		BS2050-1027	BS3550-1027
	1,50	10,00	78,00	0,20	4h6	0,33	10°	right	BS1050-2026	BS2050-2026	BS3550-2026
								left	BS1050-2027	BS2050-2027	BS3550-2027
	1,50	15,00	83,00	0,10	4h6	0,33	10°	right	BS1050-1024	BS2050-1024	BS3550-1024
								left	BS1050-1025	BS2050-1025	BS3550-1025
	1,50	15,00	83,00	0,20	4h6	0,33	10°	right	BS1050-2024	BS2050-2024	BS3550-2024
								left	BS1050-2025	BS2050-2025	BS3550-2025
3,50	1,75	6,00	74,00	0,10	4h6	0,35	10°	right		BS2050-1032	BS3550-1032
								left		BS2050-1033	BS3550-1033
	1,75	6,00	74,00	0,20	4h6	0,35	10°	right		BS2050-2032	BS3550-2032
								left		BS2050-2033	BS3550-2033
	1,75	10,00	78,00	0,10	4h6	0,35	10°	right		BS2050-1034	BS3550-1034
								left		BS2050-1035	BS3550-1035
	1,75	10,00	78,00	0,20	4h6	0,35	10°	right		BS2050-2034	BS3550-2034
								left		BS2050-2035	BS3550-2035
	1,75	15,00	80,00	0,10	4h6	0,35	10°	right	BS1050-0030	BS2050-0030	BS3550-0030
								left	BS1050-0031	BS2050-0031	BS3550-0031
	1,75	15,00	83,00	0,20	4h6	0,35	10°	right	BS1050-2030	BS2050-2030	BS3550-2030
								left	BS1050-2031	BS2050-2031	BS3550-2031
1,75	21,00	89,00	0,10	4h6	0,35	10°	right	BS1050-1036	BS2050-1036	BS3550-1036	
							left	BS1050-1037	BS2050-1037	BS3550-1037	
1,75	21,00	89,00	0,20	4h6	0,35	10°	right	BS1050-2036	BS2050-2036	BS3550-2036	
							left	BS1050-2037	BS2050-2037	BS3550-2037	

### Application range:

- PCD Aluminum <10% Si, Brass, Brass lead-free, Graphite, Titanium (Roughing) ...
- CVD-D Acrylic, Aluminum >10% Si, Carbide, Ceramics, Composites (CFRP, GFRP, MMC), Copper, Plastics, PEEK, Titanium (Finishing) ...
- CBN Steel hardened up to 72 HRC, Tool Steel up to 72 HRC, powder metallurgical Steel ...



Special tools on request for you!  
Please send inquiries to [info@diamond-toolingsystems.com](mailto:info@diamond-toolingsystems.com)



All our products are also available in the online shop.  
Visit us at [diamond-tools24.com](http://diamond-tools24.com)



Scan me!



# Precision boring bars

brazed cutting edge for internal machining from  $\varnothing$  4,00 mm

## Typ BS

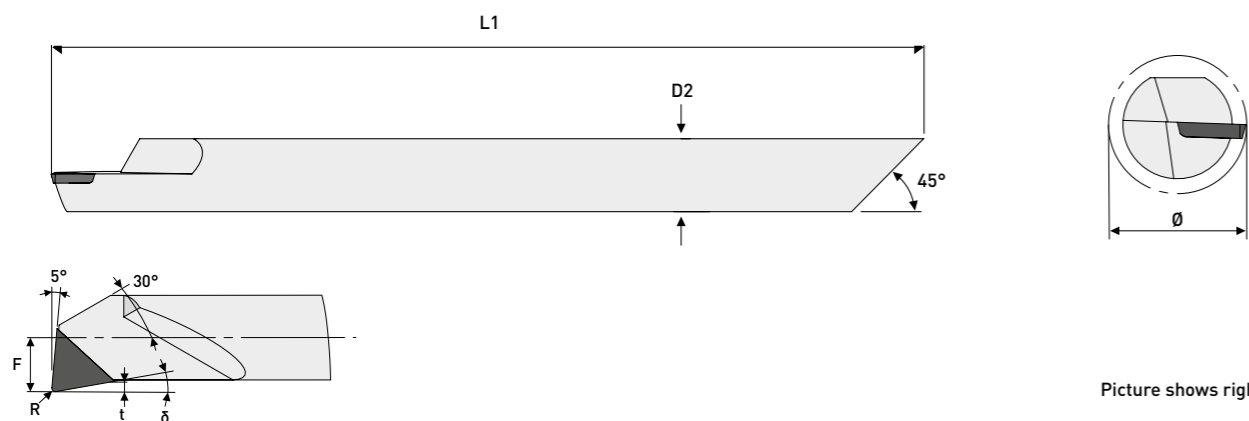

Picture shows right version

$\varnothing$	F	L2	L1	R	D2	$t_x$	$\delta$	Version	Material		
									Item No.	Item No.	Item No.
4,00	2,00	10,00	78,00	0,10	4h6	0,30	10°	right		BS2050-1132	BS3550-1132
								left		BS2050-1133	BS3550-1133
	2,00	10,00	78,00	0,20	4h6	0,30	10°	right		BS2050-2132	BS3550-2132
								left		BS2050-2133	BS3550-2133
	2,00	15,00	80,00	0,10	4h6	0,30	10°	right	BS1050-1140	BS2050-1140	BS3550-1140
								left	BS1050-1141	BS2050-1141	BS3550-1141
	2,00	15,00	83,00	0,20	4h6	0,30	10°	right	BS1050-2130	BS2050-2130	BS3550-2130
								left	BS1050-2131	BS2050-2131	BS3550-2131
	2,00	21,00	89,00	0,10	4h6	0,30	10°	right	BS1050-1134	BS2050-1134	BS3550-1038
								left	BS1050-1135	BS2050-1135	BS3550-1039
	2,00	21,00	89,00	0,20	4h6	0,30	10°	right	BS1050-2134	BS2050-2134	BS3550-2038
								left	BS1050-2135	BS2050-2135	BS3550-2039
4,50	2,25	-	78,00	0,10	4h6	0,25	10°	right		BS2050-1230	BS3550-1240
								left		BS2050-1231	BS3550-1241
	2,25	-	78,00	0,20	4h6	0,25	10°	right		BS2050-2230	BS3550-2240
								left		BS2050-2231	BS3550-2241
	2,25	-	83,00	0,10	4h6	0,25	10°	right	BS1050-1232	BS2050-1232	BS3550-1242
								left	BS1050-1233	BS2050-1233	BS3550-1243
	2,25	-	83,00	0,20	4h6	0,25	10°	right	BS1050-2232	BS2050-2232	BS3550-2242
								left	BS1050-2233	BS2050-2233	BS3550-2243
	2,25	-	89,00	0,10	4h6	0,25	10°	right		BS2050-1234	BS3550-1244
								left		BS2050-1235	BS3550-1245
	2,25	-	89,00	0,20	4h6	0,25	10°	right		BS2050-2234	BS3550-2244
								left		BS2050-2235	BS3550-2245

### Application range:

- PCD** Aluminum <10% Si, Brass, Brass lead-free, Graphite, Titanium (Roughing) ...
- CVD-D** Acrylic, Aluminum >10% Si, Carbide, Ceramics, Composites (CFRP, GFRP, MMC), Copper, Plastics, PEEK, Titanium (Finishing) ...
- CBN** Steel hardened up to 72 HRC, Tool Steel up to 72 HRC, powder metallurgical Steel ...

Suitable clamping adapters can be found from page 36.

You will find further application ranges in the detailed overview from page 8.

$\varnothing$	F	L2	L1	R	D2	$t_x$	$\delta$	Version	Material		
									Item No.	Item No.	Item No.
5,00	2,50	-	80,00	0,10	4h6	0,50	10°	right		BS2050-1240	BS3550-1040
								left		BS2050-1241	BS3550-1041
	2,50	-	80,00	0,20	4h6	0,50	10°	right	BS1050-2040	BS2050-2040	BS3550-2040
								left	BS1050-2041	BS2050-2041	BS3550-2041
	2,50	-	80,00	0,40	4h6	0,50	10°	right	BS1050-4040	BS2050-4040	BS3550-4040
								left	BS1050-4041	BS2050-4041	BS3550-4041
6,00	3,00	-	100,00	0,10	5h6	0,50	10°	right		BS2050-1050	BS3550-1050
								left		BS2050-1051	BS3550-1051
	3,00	-	100,00	0,20	5h6	0,50	10°	right	BS1050-2050	BS2050-2050	BS3550-2050
								left	BS1050-2051	BS2050-2051	BS3550-2051
	3,00	-	100,00	0,40	5h6	0,50	10°	right	BS1050-4050	BS2050-4050	BS3550-4050
								left	BS1050-4051	BS2050-4051	BS3550-4051
7,00	3,50	-	100,00	0,20	6h6	0,50	10°	right	BS1050-2060	BS2050-2060	BS3550-2060
								left	BS1050-2061	BS2050-2061	BS3550-2061
	3,50	-	100,00	0,40	6h6	0,50	10°	right	BS1050-4060	BS2050-4060	BS3550-4060
								left	BS1050-4061	BS2050-4061	BS3550-4061
9,00	4,50	-	100,00	0,20	8h6	0,50	10°	right	BS1050-2080	BS2050-2080	BS3550-2080
								left	BS1050-2081	BS2050-2081	BS3550-2081
	4,50	-	100,00	0,40	8h6	0,50	10°	right	BS1050-4080	BS2050-4080	BS3550-4080
								left	BS1050-4081	BS2050-4081	BS3550-4081



Special tools on request for you!  
 Please send inquiries to [info@diamond-toolingsystems.com](mailto:info@diamond-toolingsystems.com)



All our products are also available in the online shop.  
 Visit us at [diamond-tools24.com](http://diamond-tools24.com)



Scan me!

Subject to technical changes.



# Precision boring bars

brazed cutting edge for internal machining from  $\varnothing 3,60$  mm

## Typ BE

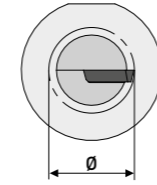
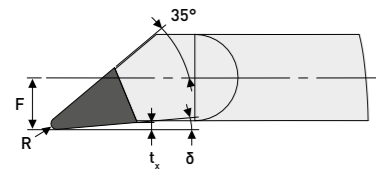
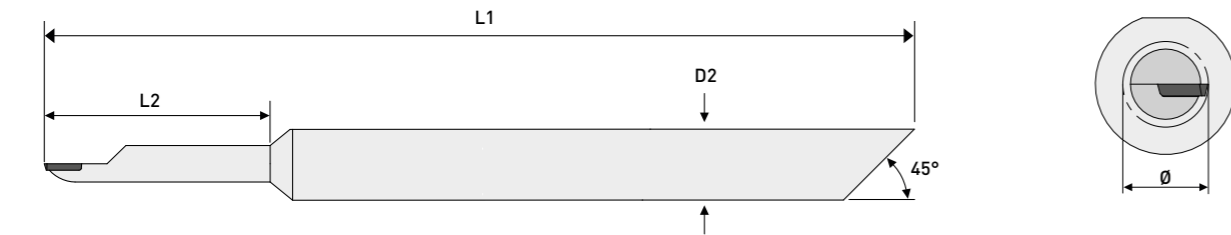

Picture shows right version



$\varnothing$	F	L2	L1	R	D2	$t_x$	$\delta$	Version	Item No. (PCD)	Item No. (CVD-D)	Item No. (CBN)
3,60	1,80	10,00	100,00	0,20	6h6	0,30	5°	right		BE2050-2130	BE3550-2130
								left		BE2050-2131	BE3550-2131
	1,80	18,00	100,00	0,20	6h6	0,30	5°	right		BE2050-2030	BE3550-2030
								left		BE2050-2031	BE3550-2031
7,00	3,50	-	100,00	0,20	6h6	0,50	5°	right		BE2050-2060	BE3550-2060
								left		BE2050-2061	BE3550-2061
	3,50	-	100,00	0,40	6h6	0,50	5°	right		BE2050-4060	BE3550-4060
								left		BE2050-4061	BE3550-4061

## Your Notes

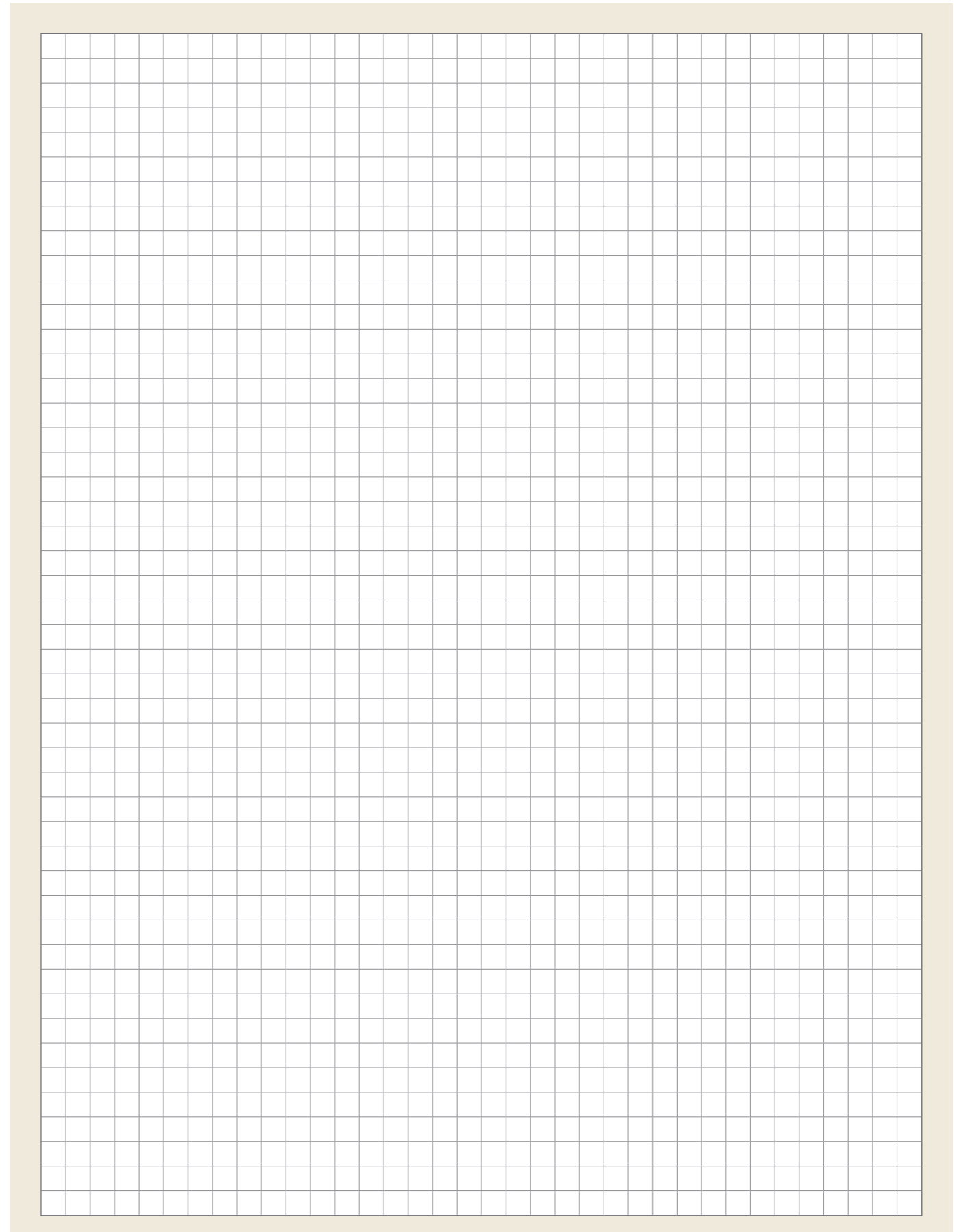

### Application range:

- **PCD** Aluminum <10% Si, Brass, Brass lead-free, Graphite, Titanium (Roughing) ...
- **CVD-D** Acrylic, Aluminum >10% Si, Carbide, Ceramics, Composites (CFRP, GFRP, MMC), Copper, Plastics, PEEK, Titanium (Finishing) ...
- **CBN** Steel hardened up to 72 HRC, Tool Steel up to 72 HRC, powder metallurgical Steel ...

# ISO Code

## Shank specification

E 08 X S C L C R 06

<b>A</b> Steel shank with internal cooling	<b>C</b> Carbide shank	<b>E</b> Carbide shank with internal cooling	<b>S</b> Steel shank
--	------------------------	--	----------------------

## Shank diameter [mm]

E 08 X S C L C R 06

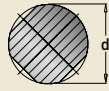
	08 = 8 mm	12 = 12 mm	20 = 20 mm	32 = 32 mm	50 = 50 mm
	10 = 10 mm	16 = 16 mm	25 = 25 mm	40 = 40 mm	60 = 60 mm



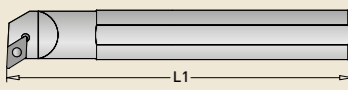

## Tool length L1 [mm]

E 08 X S C L C R 06

	F = 80 mm	L = 140 mm	P = 170 mm	S = 250 mm	V = 400 mm	X = Special
	H = 100 mm	M = 150 mm	Q = 180 mm	T = 300 mm	W = 450 mm	
	K = 125 mm	N = 160 mm	R = 200 mm	U = 350 mm	Y = 500 mm	









## Clamping system

E 08 X S C L C R 06

<b>C</b> 	<b>D</b> 	<b>M</b> 	<b>P</b> 	<b>S</b> 
---	---	---	---	---





## Insert shape

E 08 X S C L C R 06

<b>C</b> 	<b>D</b> 	<b>K</b> 	<b>R</b> 	<b>S</b> 	<b>T</b> 	<b>V</b> 	<b>W</b> 
--	--	--	--	--	--	--	---

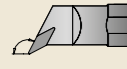

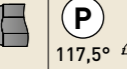
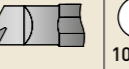
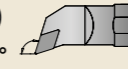





## Approach angle

E 08 X S C L C R 06

<b>F</b> 	<b>L</b> 	<b>P</b> 	<b>Q</b> 	<b>U</b> 	<b>W</b> 
--	--	--	--	--	---

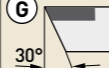

## Insert clearance angle

E 08 X S C L C R 06

<b>A</b> 	<b>B</b> 	<b>C</b> 	<b>D</b> 	<b>E</b> 	<b>F</b> 	<b>G</b> 	<b>H</b> 	<b>I</b> 
--	--	--	--	--	--	---	--	--



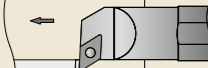



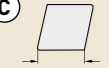

## Hand of tool

E 08 X S C L C R 06

<b>R</b> 	<b>L</b> 
--	--

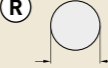
## Cutting edge length [mm]

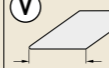
E 08 X S C L C R 06

<b>C</b> 	<b>E</b> 	<b>D</b> 	<b>K</b> 	<b>R</b> 	<b>S</b> 	<b>T</b> 	<b>V</b> 	<b>W</b> 
--	--	--	--	--	--	---	--	--

# MiniTools

Carbide Boring Bars and multi-edged Inserts tipped with Diamond or CBN

## Boring Tools with Carbide Tool Holders:

- ✓ Highly economical due to multi-edged inserts
- ✓ Starting from bore Ø 3,50 mm
- ✓ Low vibration carbide design
- ✓ With inner cooling
- ✓ For internal turning on lathes
- ✓ For spindle turning on milling machines

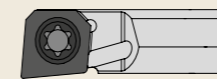

MT-SCLDR/L



MT-SCLDR/L

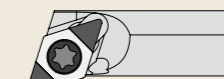

MT-SDQCR/L

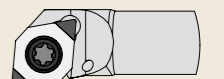

MT-SELPR/L

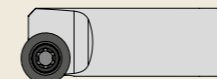

MT-SRLCR/L



MT-SVXCR/L



MT-STXPR/L



MT-SWUCR/L

## Large selection of multi-edged indexable inserts!



## Application range of our diamond indexable inserts:

- ✓ All abrasive non-ferrous materials
- ✓ Aluminum
- ✓ Carbide G-Grade
- ✓ Carbide K-Grade
- ✓ Carbide with Ni Binder
- ✓ Ceramic Materials
- ✓ Composite such as CFRP / GFRP
- ✓ Copper Alloys
- ✓ Glass and Glass Ceramic
- ✓ MMC
- ✓ Other brittle non-ferrous materials
- ✓ Titanium (Finishing)

## Application range of our CBN indexable inserts:

- ✓ Cast Iron
- ✓ Special Alloys such as ASP, CPM, Hardox
- ✓ Steel hardened up to 72 HRC
- ✓ Stellite
- ✓ Tool Steel up to 72 HRC

CDGW 03 ...  
FullFace (Z1)



from Ø 3,50

CDGW 04 ...  
Z2



from Ø 4,80

DCGW 05 ...  
Z2



from Ø 5,20

EPGW 05 ...  
Z2



from Ø 8,00

TPGW 06 ...  
Z1



from Ø 8,00

VCGW 05 ...  
Z2



from Ø 8,00

WCGW 02 ...  
Z3



from Ø 5,80

Inserts available with radii from 0.10 mm to 0.40 mm.

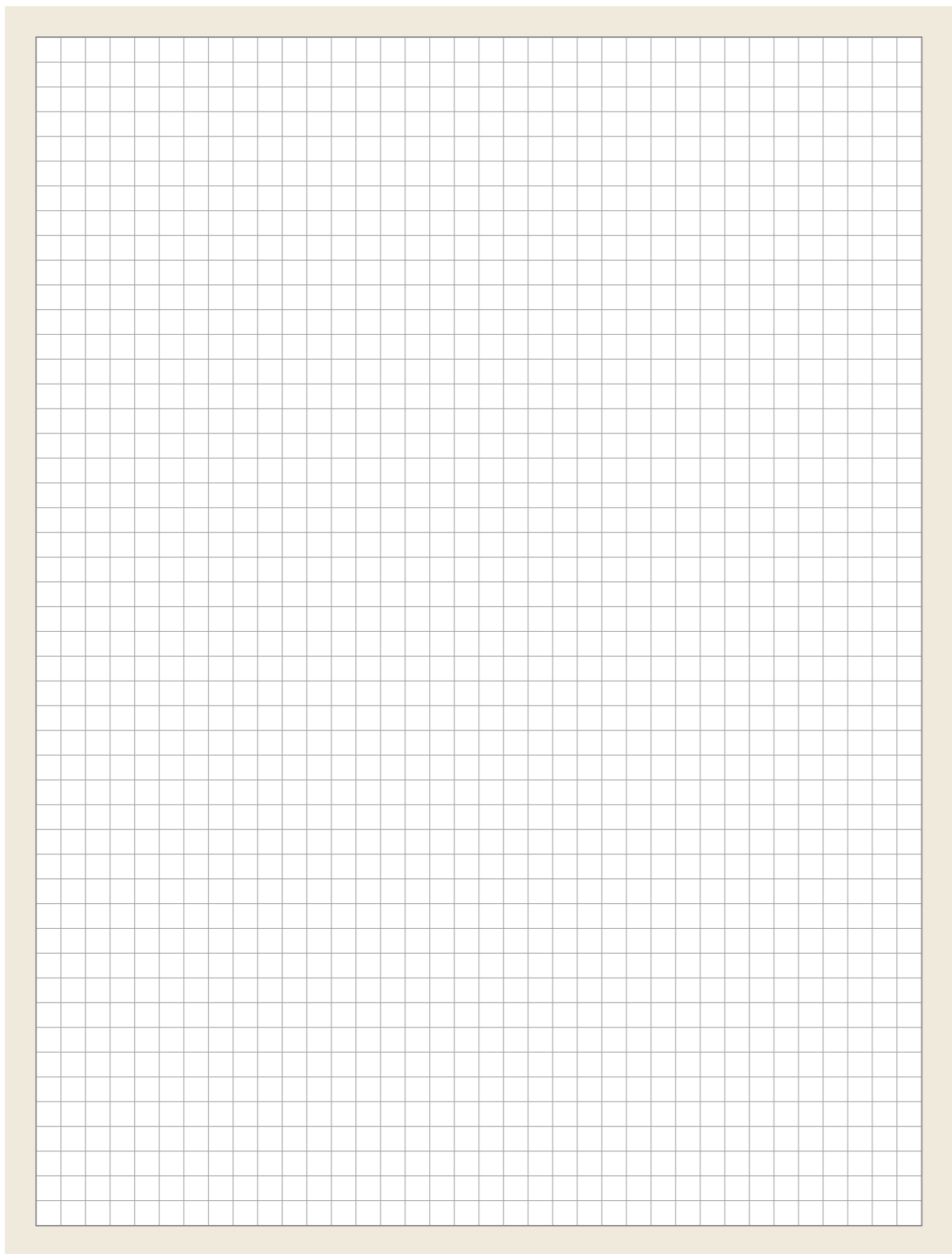

# MT... SCLDR/L 95°/5°

full-length shaft | for cutting inserts CDGW 03...

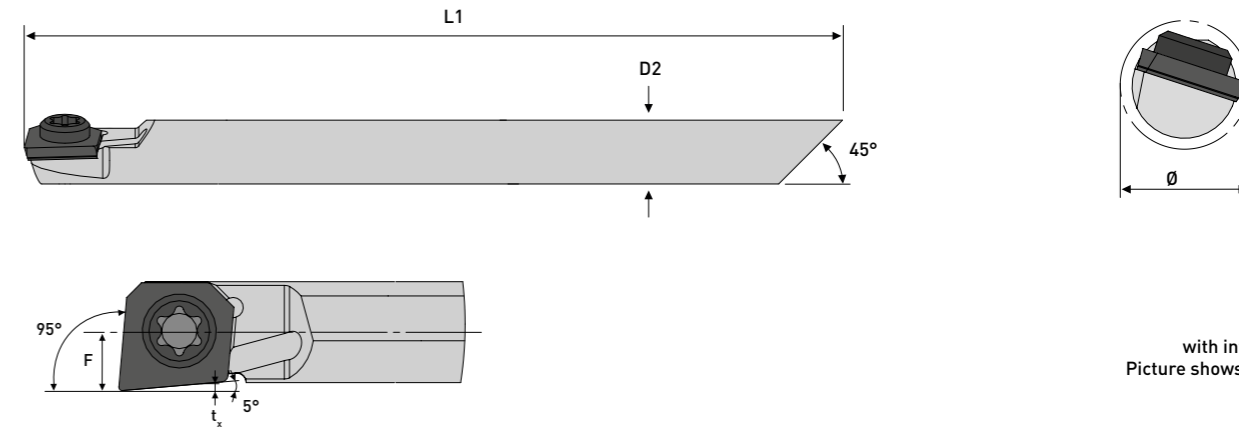

Ø	L2	L1	D2	Version	Iso Code	Item No.	Clamping Screw
3,50	-	80,00	3h6	right	MT03X SCLDR 03	BW6060-0234	01-KL9060-0016
				left	MT03X SCLDL 03	BW6060-0235	01-KL9060-0016



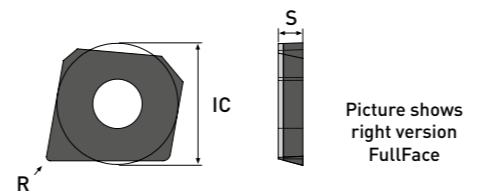

 Tightening torque 0,15 Nm

Iso Code	Radius	tx-Maß	f-Maß
CDGW 03...	R0,1	0,24	1,74
	R0,2	0,22	1,73



Iso Code	IC	S	R	CVD-D Diamond	Ultra Diamant	CBN-H	CBN-K	CBN-X
				Item No.	Item No.	Item No.	Item No.	Item No.
CDGW 03X101-Rechts	3,20	0,63	0,10	DP2030-0500	-	TI5030-0500	TI5530-0500	TI5930-0500
CDGW 03X102-Rechts	3,20	0,63	0,20	DP2030-0502	-	TI5030-0502	TI5530-0502	TI5930-0502
CDGW 03X101-Links	3,20	0,63	0,10	DP2030-0501	-	TI5030-0501	TI5530-0501	TI5930-0501
CDGW 03X102-Links	3,20	0,63	0,20	DP2030-0503	-	TI5030-0503	TI5530-0503	TI5930-0503

**Application range:**

-  CVD-D Aluminium, Carbide >10%Co, Brass, Brass bleifrei, Graphit, Verbundwerkstoffe (CFK, GFK, MMC), Titanium ...
-  UltraDia. Acryl, Ceramic, Carbide <12%Co, Zirkon ...
-  CBN-H Steel gehärtet bis 72 HRC
-  CBN-K Grey Cast Iron (GG), Ductile Cast Iron (GGG) ...
-  CBN-X Hardened tool steel, stellite, hardened stainless steel, powder metallurgical steel, hardened ...

Suitable clamping adapters can be found from page 36.

You will find further application ranges in the detailed overview from page 8.

# MT... SCLDR/L 95°/5°

stepped shaft | for cutting inserts CDGW 0401...

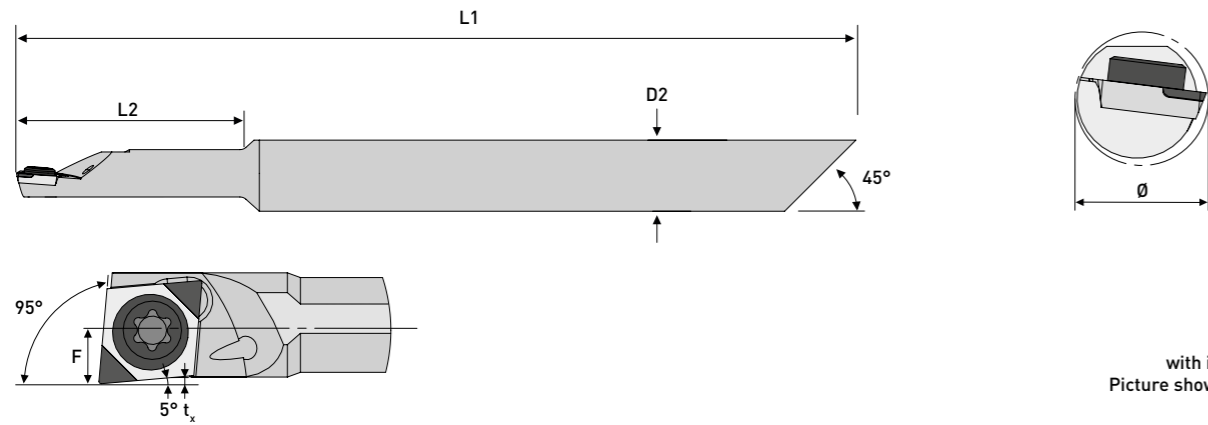

with internal cooling  
Picture shows right version

Ø	L2	L1	D2	Version	Iso Code	Item No.	Clamping Screw
4,80	24,00	80,00	8h6	right	MT0408X SCLDR 04	BW6060-0130	01-BW9060-0011
				left	MT0408X SCLDL 04	BW6060-0131	01-BW9060-0011
5,80	21,50	100,00	8h6	right	MT0508X SCLDR 04	BW6060-0132	01-BW9060-0011
				left	MT0508X SCLDL 04	BW6060-0133	01-BW9060-0011
6,80	22,00	100,00	8h6	right	MT0608X SCLDR 04	BW6060-0134	01-BW9060-0011
				left	MT0608X SCLDL 04	BW6060-0135	01-BW9060-0011

Tightening torque 0,45 Nm

Iso Code	Radius	tx-Maß	f-Maß
CDGW 0401...	R0,1	0,31	2,51
	R0,2	0,30	2,50
	R0,4	0,28	2,48

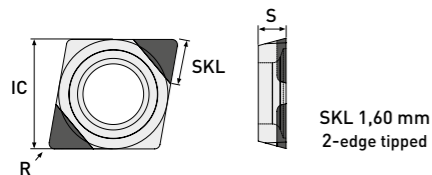

Iso Code	IC	S	R	CVD-D Diamond Item No.	Ultra Diamant Item No.	CBN-H Item No.	CBN-K Item No.	CBN-X Item No.
CDGW 040101	3,97	1,00	0,10	DP2010-0511	DP1110-1480	TI5010-1511	TI5510-2510	TI5910-2510
CDGW 040102	3,97	1,00	0,20	DP2010-0512	DP1110-1482	TI5010-1512	TI5510-2512	TI5910-2512
CDGW 040104	3,97	1,00	0,40	DP2010-0513	DP1110-1484	TI5010-1513	TI5510-2514	TI5910-2514

### Application range:

- CVD-D** Aluminum, Brass, Brass lead-free, Composites (CFRP, GFRP, MMC), Graphite, Titanium ...
- UltraDia.** Acrylic, Carbide < 10% Binder, Ceramics, Zirconium ...
- CBN-H** Steel hardened up to 72 HRC
- CBN-K** Tool Steel hardened up to 72 HRC, Tool Steel low alloy, Stellite, Powder Metallurgical Steel ...
- CBN-X** Grey Cast Iron (GCI), Ductile Cast Iron (DCI) ...

You will find suitable Clamping Adapters on page 36.

You will find further application ranges in the detailed overview on page 8.

# MT... SCLDR/L 95°/5°

full-length shaft | for cutting inserts CDGW 0401...

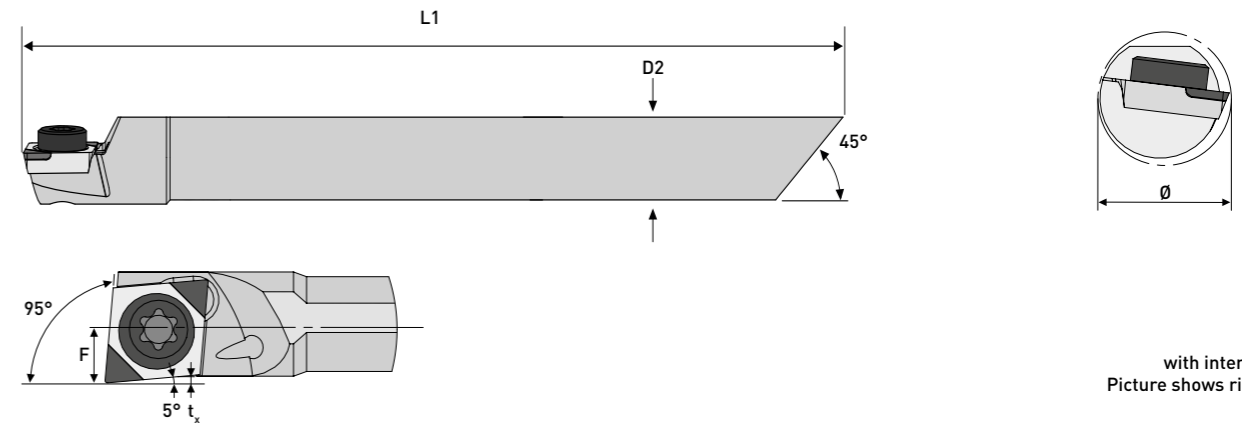

with internal cooling  
Picture shows right version

Ø	L2	L1	D2	Version	Iso Code	Item No.	Clamping Screw
4,80	-	80,00	4h6	right	MT04X SCLDR 04	BW6060-0120	01-BW9060-0011
				left	MT04X SCLDL 04	BW6060-0121	01-BW9060-0011
5,80	-	100,00	5h6	right	MT05X SCLDR 04	BW6060-0122	01-BW9060-0011
				left	MT05X SCLDL 04	BW6060-0123	01-BW9060-0011
6,80	-	100,00	6h6	right	MT06X SCLDR 04	BW6060-0124	01-BW9060-0011
				left	MT06X SCLDL 04	BW6060-0125	01-BW9060-0011

Tightening torque 0,45 Nm

Iso Code	Radius	tx-Maß	f-Maß
CDGW 0401...	R0,1	0,45	3,51
	R0,2	0,44	3,50
	R0,4	0,42	3,48

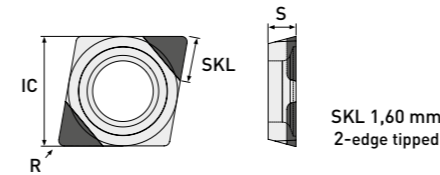

Iso Code	IC	S	R	CVD-D Diamond Item No.	Ultra Diamant Item No.	CBN-H Item No.	CBN-K Item No.	CBN-X Item No.
CDGW 040101	3,97	1,00	0,10	DP2010-0511	DP1110-1480	TI5010-1511	TI5510-2510	TI5910-2510
CDGW 040102	3,97	1,00	0,20	DP2010-0512	DP1110-1482	TI5010-1512	TI5510-2512	TI5910-2512
CDGW 040104	3,97	1,00	0,40	DP2010-0513	DP1110-1484	TI5010-1513	TI5510-2514	TI5910-2514

Special tools on request for you!  
Please send inquiries to [info@diamond-toolingsystems.com](mailto:info@diamond-toolingsystems.com)

All our products are also available in the online shop.  
Visit us at [diamond-tools24.com](http://diamond-tools24.com)

You can find our complete holder program in our tool holder catalog or in our online shop.



Scan me!

Subject to technical changes.



# MT... SDQCR/L 107,5°/17,5°

stepped shaft | for cutting inserts DCGW 04T0...

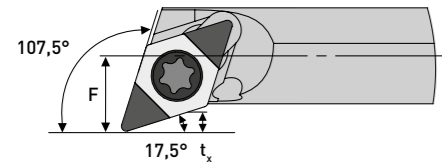
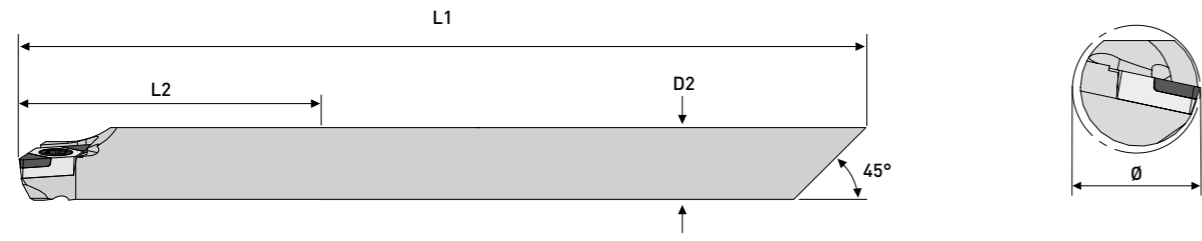

with internal cooling  
Picture shows right version

Ø	L2	L1	D2	Version	Iso Code	Item No.	Clamping Screw
5,20	25,00	100,00	5h6	right	MT0405X SDQCR 04	BW6060-0166	01-BW9060-0010
				left	MT0405X SDQCL 04	BW6060-0167	01-BW9060-0010

Tightening torque 0,45 Nm

Iso Code	Radius	tx-Maß	f-Maß
DCGW 04T0...	R0,1	1,16	3,01
	R0,2	1,11	2,96
	R0,4	1,00	2,85

# MT... SDUCR/L 93°/32°

stepped shaft | for cutting inserts DCGW 04T0...

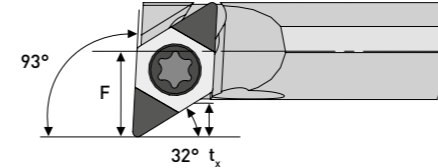
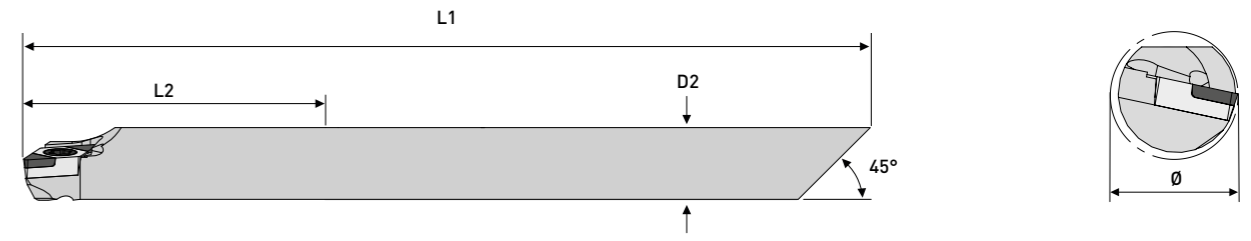

with internal cooling  
Picture shows right version

Ø	L2	L1	D2	Version	Iso Code	Item No.	Clamping Screw
5,80	25,00	100,00	5h6	right	MT0405X SDUCR 04	BW6060-0160	01-BW9060-0010
				left	MT0405X SDUCL 04	BW6060-0161	01-BW9060-0010

Tightening torque 0,45 Nm

Iso Code	Radius	tx-Maß	f-Maß
DCGW 04T0...	R0,1	1,60	3,56
	R0,2	1,51	3,47
	R0,4	1,34	3,30

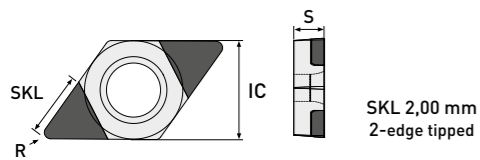

SKL 2,00 mm  
2-edge tipped



Iso Code	IC	S	R	Item No.	Item No.	Item No.	Item No.	Item No.
DCGW 04T001	3,10	1,20	0,10	DP2010-0521	DP1110-1492	TI5010-1521	TI5510-2522	TI5910-2522
DCGW 04T002	3,10	1,20	0,20	DP2010-0522	DP1110-1494	TI5010-1522	TI5510-2524	TI5910-2524
DCGW 04T004	3,10	1,20	0,40	DP2010-0523	DP1110-1496	TI5010-1523	TI5510-2526	TI5910-2526

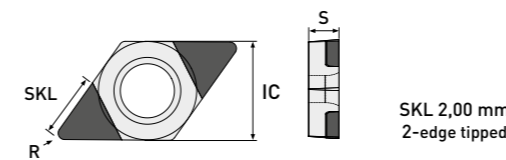

SKL 2,00 mm  
2-edge tipped



Iso Code	IC	S	R	Item No.	Item No.	Item No.	Item No.	Item No.
DCGW 04T001	3,10	1,20	0,10	DP2010-0521	DP1110-1492	TI5010-1521	TI5510-2522	TI5910-2522
DCGW 04T002	3,10	1,20	0,20	DP2010-0522	DP1110-1494	TI5010-1522	TI5510-2524	TI5910-2524
DCGW 04T004	3,10	1,20	0,40	DP2010-0523	DP1110-1496	TI5010-1523	TI5510-2526	TI5910-2526

### Application range:

- CVD-D Aluminum, Brass, Brass lead-free, Composites (CFRP, GFRP, MMC), Graphite, Titanium ...
- UltraDia. Acrylic, Carbide < 10% Binder, Ceramics, Zirconium ...
- CBN-H Steel hardened up to 72 HRC
- CBN-K Tool Steel hardened up to 72 HRC, Tool Steel low alloy, Stellite, Powder Metallurgical Steel ...
- CBN-X Grey Cast Iron (GCI), Ductile Cast Iron (DCI) ...

You will find suitable Clamping Adapters on page 36.

You will find further application ranges in the detailed overview on page 8.



Special tools on request for you!  
Please send inquiries to [info@diamond-toolingsystems.com](mailto:info@diamond-toolingsystems.com)



All our products are also available in the online shop.  
Visit us at [diamond-tools24.com](http://diamond-tools24.com)

You can find our complete holder program in our tool holder catalog or in our online shop.



Scan me!

Subject to technical changes.

# MT... SELPR/L 95°/10°

stepped shaft | for cutting inserts EPGW 0502...

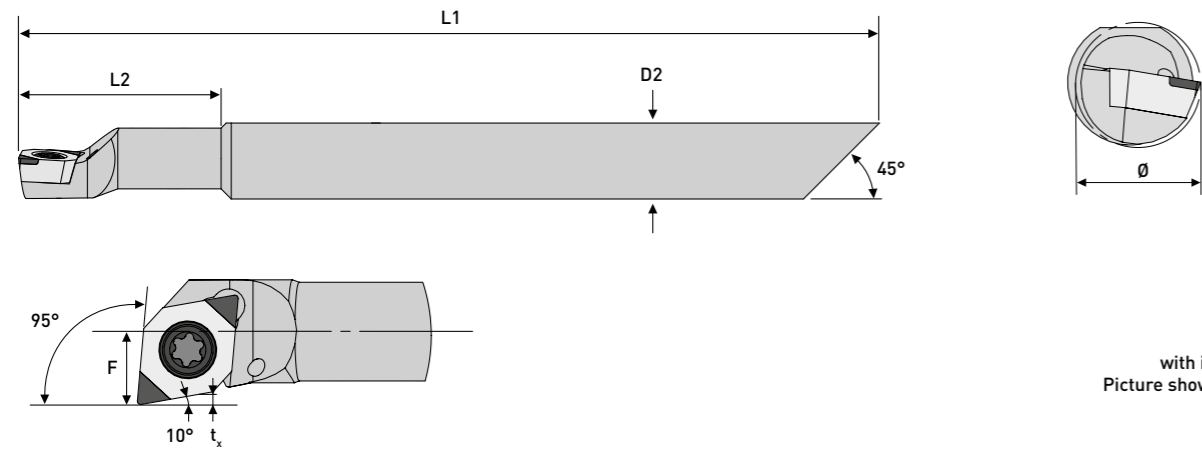

with internal cooling  
Picture shows right version

Ø	L2	L1	D2	Version	Iso Code	Item No.	Clamping Screw
8,00	20,00	100,00	8h6	right	MT0608X SELPR 05	BW6060-0150	01-BW9060-0005
				left	MT0608X SELPL 05	BW6060-0151	01-BW9060-0005
11,00	33,00	100,00	10h6	right	MT0810X SELPR 05	BW6060-0152	01-BW9060-0005
				left	MT0810X SELPL 05	BW6060-0153	01-BW9060-0005

Tightening torque 0,45 Nm

Iso Code	Radius	tx-Maß	f-Maß
EPGW 0502...	R0,1	1,18	4,52
	R0,2	1,16	4,50
	R0,4	1,11	4,45

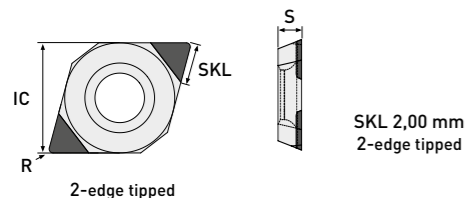

SKL 2,00 mm  
2-edge tipped

Iso Code	IC	S	R	CVD-D Diamond	Ultra Diamant	CBN-H	CBN-K	CBN-X
				Item No.	Item No.	Item No.	Item No.	Item No.
EPGW 050201	5,56	2,38	0,10	DP2010-0531	DP1110-1400	TI5010-1531	TI5510-2550	TI5910-2550
EPGW 050202	5,56	2,38	0,20	DP2010-0532	DP1110-1402	TI5010-1532	TI5510-2552	TI5910-2552
EPGW 050204	5,56	2,38	0,40	DP2010-0533	DP1110-1404	TI5010-1533	TI5510-2554	TI5910-2554

### Application range:

- CVD-D Aluminum, Brass, Brass lead-free, Composites (CFRP, GFRP, MMC), Graphite, Titanium ...
- UltraDia. Acrylic, Carbide < 10% Binder, Ceramics, Zirconium ...
- CBN-H Steel hardened up to 72 HRC
- CBN-K Tool Steel hardened up to 72 HRC, Tool Steel low alloy, Stellite, Powder Metallurgical Steel ...
- CBN-X Grey Cast Iron (GCI), Ductile Cast Iron (DCI) ...

You will find suitable Clamping Adapters on page 36.

You will find further application ranges in the detailed overview on page 8.

# MT... SRLCR/L 95°/10°

full-length shaft | for cutting inserts RCGW 0602...

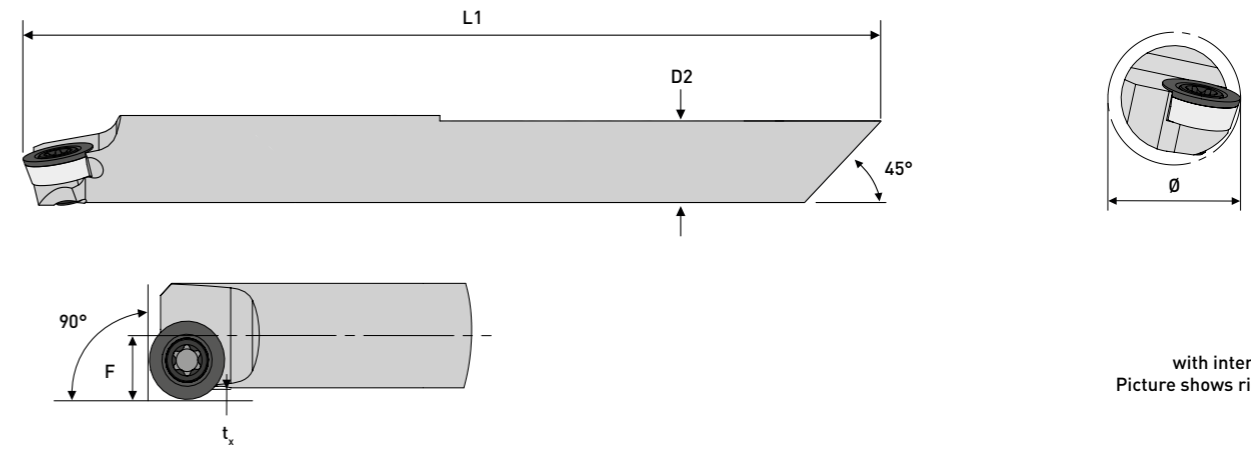

with internal cooling  
Picture shows right version

Ø	L2	L1	D2	Version	Iso Code	Item No.	Clamping Screw
10,00	-	125,00	8h6	right	MT08X SRLCR 06	BW6060-1024	01-KL9060-0001
				left	MT08X SRLCL 06	BW6060-1025	01-KL9060-0001

Tightening torque 1,00 Nm

Iso Code	Radius	tx-Maß	f-Maß
RCGW 0602...	M0	1,00	5,00

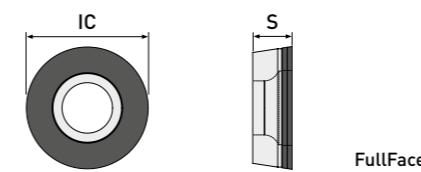

FullFace

Iso Code	IC	S	R	PCD Diamond	CVD-D Diamond	CBN-H	CBN-K	CBN-X
				Item No.	Item No.	Item No.	Item No.	Item No.
RCGW 0602M0 FF	6,00	2,38	-	DP1030-0001	DP2030-0001	TI5030-0100	TI5530-0102	TI5930-0102



Special tools on request for you!  
Please send inquiries to [info@diamond-toolingsystems.com](mailto:info@diamond-toolingsystems.com)



All our products are also available in the online shop.  
Visit us at [diamond-tools24.com](http://diamond-tools24.com)

You can find our complete holder program in our tool holder catalog or in our online shop.



Scan me!

Subject to technical changes.

# MT... STXPR/L 62,5°/57,5°

stepped shaft | for cutting inserts TPGW 06T1...

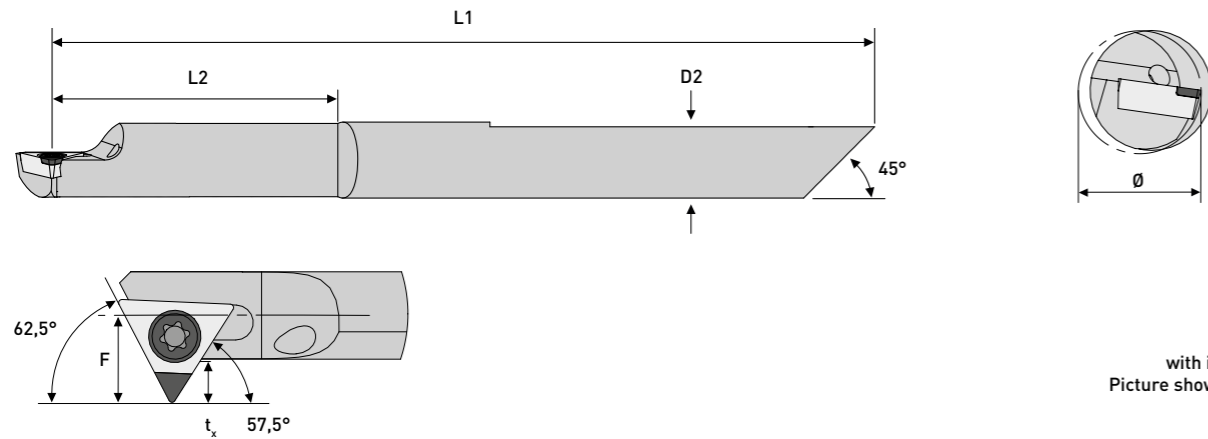

with internal cooling  
Picture shows right version

ø	L2	L1	D2	Version	Iso Code	Item No.	Clamping Screw
8,00	40,00	100,00	6h6	right	MT06X STXPR 06	BW6060-0126	01-BW9060-0126
				left	MT06X STXPL 06	BW6060-0127	01-BW9060-0126

Tightening torque 0,45 Nm

Iso Code	Radius	tx-Maß	f-Maß
TPGW 06T1...	R0,1	1,65	3,57
	R0,2	1,55	3,47
	R0,4	1,35	3,27

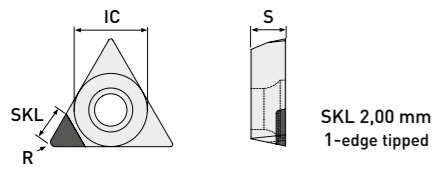

Iso Code	IC	S	R	Item No.	Item No.	Item No.	Item No.	Item No.
TPGW 06T101	3,97	1,98	0,10	DP2010-0671	DP1110-1410	TI5010-0786	TI5510-0786	TI5910-0786
TPGW 06T102	3,97	1,98	0,20	DP2010-0672	DP1110-1412	TI5010-0787	TI5510-0787	TI5910-0787
TPGW 06T104	3,97	1,98	0,40	DP2010-0673	DP1110-1414	TI5010-0788	TI5510-0788	TI5910-0788

### Application range:

- CVD-D** Aluminum, Brass, Brass lead-free, Composites (CFRP, GFRP, MMC), Graphite, Titanium ...
- UltraDia.** Acrylic, Carbide < 10% Binder, Ceramics, Zirconium ...
- CBN-H** Steel hardened up to 72 HRC
- CBN-K** Tool Steel hardened up to 72 HRC, Tool Steel low alloy, Stellite, Powder Metallurgical Steel ...
- CBN-X** Grey Cast Iron (GCI), Ductile Cast Iron (DCI) ...

You will find suitable Clamping Adapters on page 36.

You will find further application ranges in the detailed overview on page 8.

# MT... SVXCR/L 5°/140°

stepped shaft | for cutting inserts VCGW 0501...

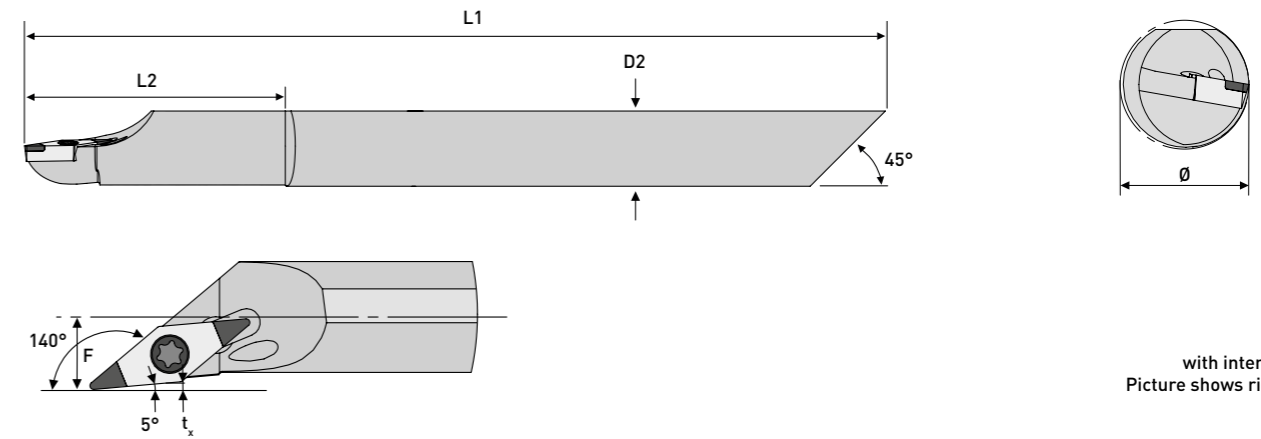

with internal cooling  
Picture shows right version

ø	L2	L1	D2	Version	Iso Code	Item No.	Clamping Screw
8,00	26,00	80,00	8h6	right	MT08X SVXCR 05 5°	BW6060-0180	01-BW9060-0010
				left	MT08X SVXCL 05 5°	BW6060-0181	01-BW9060-0010

Tightening torque 0,45 Nm

Iso Code	Radius	tx-Maß	f-Maß
VCGW 0501...	R0,1	0,95	3,97
	R0,2	0,92	3,94
	R0,4	0,87	3,88

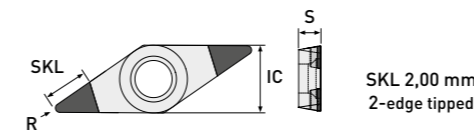

Iso Code	IC	S	R	Item No.	Item No.	Item No.	Item No.	Item No.
VCGW 050101	3,10	1,59	0,10	DP2010-0561	DP1110-1498	TI5010-1561	TI5510-2528	TI5910-2528
VCGW 050102	3,10	1,59	0,20	DP2010-0562	DP1110-1500	TI5010-1562	TI5510-2530	TI5910-2530
VCGW 050104	3,10	1,59	0,40	DP2010-0563	DP1110-1502	TI5010-1563	TI5510-2532	TI5910-2532

Special tools on request for you!  
Please send inquiries to [info@diamond-toolingsystems.com](mailto:info@diamond-toolingsystems.com)

All our products are also available in the online shop.  
Visit us at [diamond-tools24.com](http://diamond-tools24.com)

You can find our complete holder program in our tool holder catalog or in our online shop.



Scan me!

Subject to technical changes.

# MT... SVXCR/L 113°/32°

stepped shaft | for cutting inserts VCGW 0501...

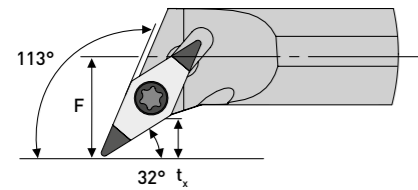
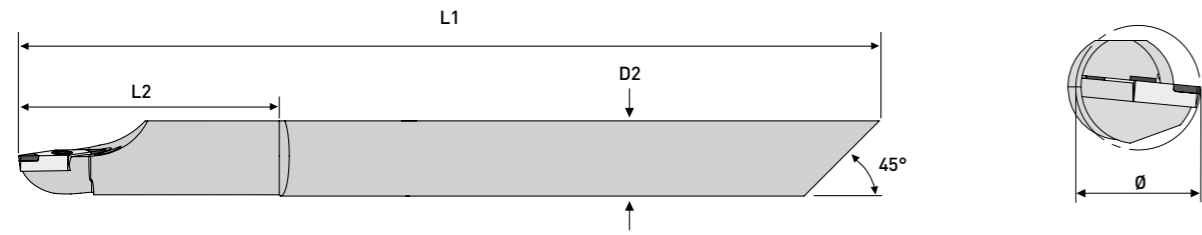

with internal cooling  
Picture shows right version

Ø	L2	L1	D2	Version	Iso Code	Item No.	Clamping Screw
9,20	26,00	80,00	8h6	right	MT08X SVXCR 05 113°	BW6060-0186	01-BW9060-0010
				left	MT08X SVXCL 05 113°	BW6060-0187	01-BW9060-0010

Tightening torque 0,45 Nm

Iso Code	Radius	tx-Maß	f-Maß
VCGW 0501...	R0,1	3,35	6,36
	R0,2	3,20	6,20
	R0,4	2,89	5,90

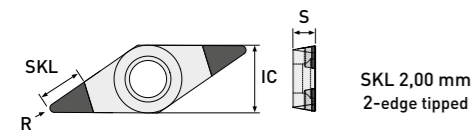

Iso Code	IC	S	R	CVD-D Diamond	Ultra Diamant	CBN-H	CBN-K	CBN-X
				Item No.	Item No.	Item No.	Item No.	Item No.
VCGW 050101	3,10	1,59	0,10	DP2010-0561	DP1110-1498	TI5010-1561	TI5510-2528	TI5910-2528
VCGW 050102	3,10	1,59	0,20	DP2010-0562	DP1110-1500	TI5010-1562	TI5510-2530	TI5910-2530
VCGW 050104	3,10	1,59	0,40	DP2010-0563	DP1110-1502	TI5010-1563	TI5510-2532	TI5910-2532

### Application range:

- CVD-D Aluminum, Brass, Brass lead-free, Composites (CFRP, GFRP, MMC), Graphite, Titanium ...
- UltraDia. Acrylic, Carbide < 10% Binder, Ceramics, Zirconium ...
- CBN-H Steel hardened up to 72 HRC
- CBN-K Tool Steel hardened up to 72 HRC, Tool Steel low alloy, Stellite, Powder Metallurgical Steel ...
- CBN-X Grey Cast Iron (GCI), Ductile Cast Iron (DCI) ...

You will find suitable Clamping Adapters on page 36.

You will find further application ranges in the detailed overview on page 8.

# MT... SVLCR/L 95°/50°

stepped shaft | for cutting inserts VCGW 0501...

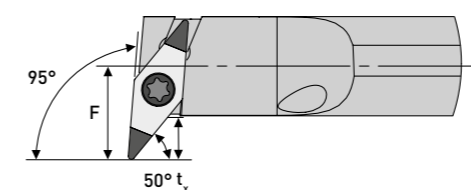
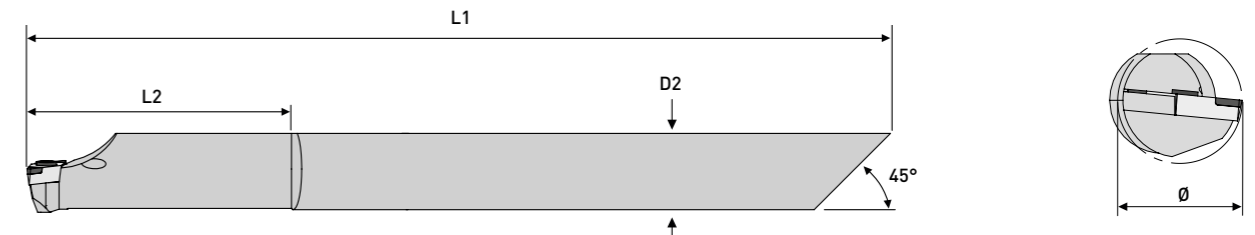

with internal cooling  
Picture shows right version

Ø	L2	L1	D2	Version	Iso Code	Item No.	Clamping Screw
9,20	26,00	80,00	8h6	right	MT08X SVLCR 05	BW6060-0190	01-BW9060-0010
				left	MT08X SVLCL 05	BW6060-0191	01-BW9060-0010

Tightening torque 0,45 Nm

Iso Code	Radius	tx-Maß	f-Maß
VCGW 0501...	R0,1	3,21	6,18
	R0,2	3,00	5,97
	R0,4	2,58	5,56

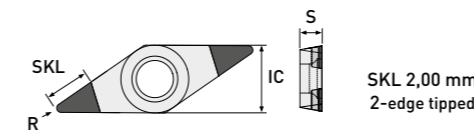

Iso Code	IC	S	R	CVD-D Diamond	Ultra Diamant	CBN-H	CBN-K	CBN-X
				Item No.	Item No.	Item No.	Item No.	Item No.
VCGW 050101	3,10	1,59	0,10	DP2010-0561	DP1110-1498	TI5010-1561	TI5510-2528	TI5910-2528
VCGW 050102	3,10	1,59	0,20	DP2010-0562	DP1110-1500	TI5010-1562	TI5510-2530	TI5910-2530
VCGW 050104	3,10	1,59	0,40	DP2010-0563	DP1110-1502	TI5010-1563	TI5510-2532	TI5910-2532

Special tools on request for you!  
Please send inquiries to [info@diamond-toolingsystems.com](mailto:info@diamond-toolingsystems.com)

All our products are also available in the online shop.  
Visit us at [diamond-tools24.com](http://diamond-tools24.com)

You can find our complete holder program in our tool holder catalog or in our online shop.



Scan me!

Subject to technical changes.



# MT... SVVCR 72,5°/72,5°

stepped shaft | for cutting inserts VCGW 0501...

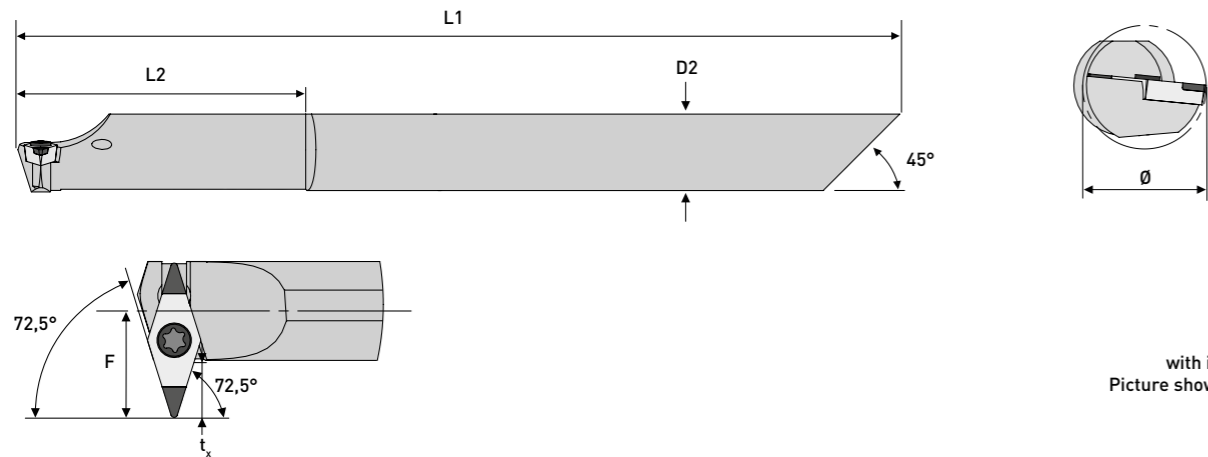

with internal cooling  
Picture shows right version

Ø	L2	L1	D2	Version	Iso Code	Item No.	Clamping Screw
10,00	26,00	80,00	8h6	right	MT08X SVVCR 05	BW6060-0196	01-BW9060-0010

Tightening torque 0,45 Nm

Iso Code	Radius	tx-Maß	f-Maß
VCGW 0501...	R0,1	3,74	6,70
	R0,2	3,31	6,27
	R0,4	3,05	6,00

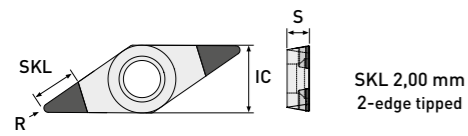

SKL 2,00 mm  
2-edge tipped

Iso Code	IC	S	R	CVD-D Diamond	Ultra Diamant	CBN-H	CBN-K	CBN-X
				Item No.	Item No.	Item No.	Item No.	Item No.
VCGW 050101	3,10	1,59	0,10	DP2010-0561	DP1110-1498	TI5010-1561	TI5510-2528	TI5910-2528
VCGW 050102	3,10	1,59	0,20	DP2010-0562	DP1110-1500	TI5010-1562	TI5510-2530	TI5910-2530
VCGW 050104	3,10	1,59	0,40	DP2010-0563	DP1110-1502	TI5010-1563	TI5510-2532	TI5910-2532

### Application range:

- CVD-D Aluminum, Brass, Brass lead-free, Composites (CFRP, GFRP, MMC), Graphite, Titanium ...
- UltraDia. Acrylic, Carbide < 10% Binder, Ceramics, Zirconium ...
- CBN-H Steel hardened up to 72 HRC
- CBN-K Tool Steel hardened up to 72 HRC, Tool Steel low alloy, Stellite, Powder Metallurgical Steel ...
- CBN-X Grey Cast Iron (GCI), Ductile Cast Iron (DCI) ...

You will find suitable Clamping Adapters on page 36.

You will find further application ranges in the detailed overview on page 8.

# MT... SVXCR/L 50°/95° EX

stepped shaft | for cutting inserts VCGW 0501...

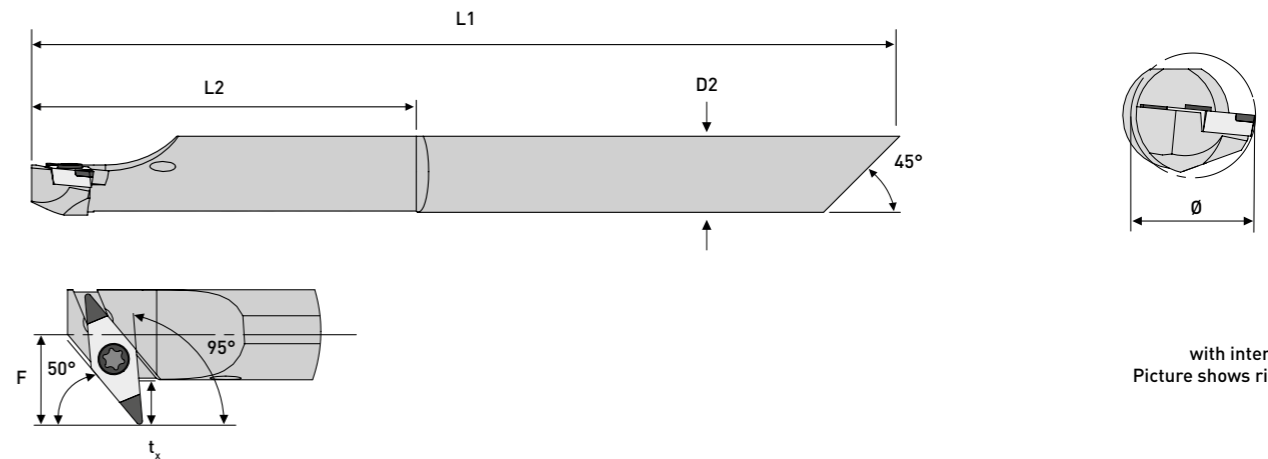

with internal cooling  
Picture shows right version

Ø	L2	L1	D2	Version	Iso Code	Item No.	Clamping Screw
9,20	26,00	80,00	8h6	right	MT08X SVXCR 05	BW6060-0200	01-BW9060-0010
				left	MT08X SVXCR 05	BW6060-0201	01-BW9060-0010

Tightening torque 0,45 Nm

Iso Code	Radius	tx-Maß	f-Maß
VCGW 0501...	R0,1	3,18	6,18
	R0,2	2,97	5,97
	R0,4	2,55	5,56

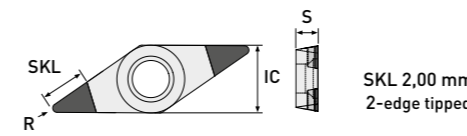

SKL 2,00 mm  
2-edge tipped

Iso Code	IC	S	R	CVD-D Diamond	Ultra Diamant	CBN-H	CBN-K	CBN-X
				Item No.	Item No.	Item No.	Item No.	Item No.
VCGW 050101	3,10	1,59	0,10	DP2010-0561	DP1110-1498	TI5010-1561	TI5510-2528	TI5910-2528
VCGW 050102	3,10	1,59	0,20	DP2010-0562	DP1110-1500	TI5010-1562	TI5510-2530	TI5910-2530
VCGW 050104	3,10	1,59	0,40	DP2010-0563	DP1110-1502	TI5010-1563	TI5510-2532	TI5910-2532

Special tools on request for you!  
Please send inquiries to [info@diamond-toolingsystems.com](mailto:info@diamond-toolingsystems.com)

All our products are also available in the online shop.  
Visit us at [diamond-tools24.com](http://diamond-tools24.com)

You can find our complete holder program in our tool holder catalog or in our online shop.



Scan me!

Subject to technical changes.

# MT... SWUCR/L 93°/7°

full-length shaft | for cutting inserts WCGW 0201...

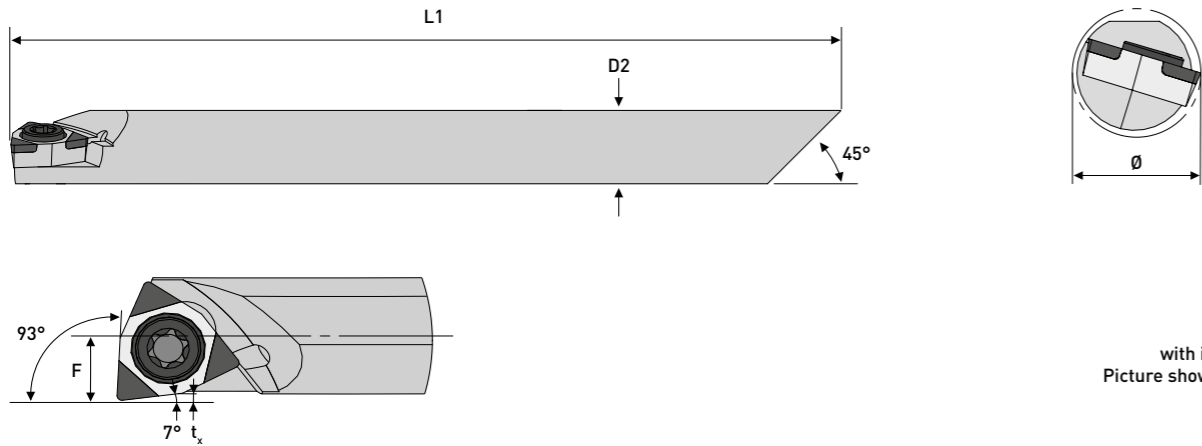

with internal cooling  
Picture shows right version

Ø	L2	L1	D2	Version	Iso Code	Item No.	Clamping Screw
5,80	-	100,00	5h6	right	MT05X SWUCR 02	BW6060-0090	01-BW9060-0012
				left	MT05X SWUCL 02	BW6060-0091	01-BW9060-0012
7,80	-	100,00	6h6	right	MT06X SWUCR 02	BW6060-0094	01-BW9060-0012
				left	MT06X SWUCL 02	BW6060-0095	01-BW9060-0012

Tightening torque 0,60 Nm

Iso Code	Radius	tx-Maß	f-Maß
WCGW 0201...	R0,1	0,41	2,67
	R0,2	0,40	2,65
	R0,4	0,37	2,63

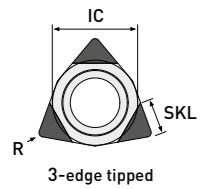

SKL 1,60 mm  
2-edge tipped

Iso Code	IC	S	R	CVD-D Diamond	Ultra Diamant	CBN-H	CBN-K	CBN-X
				Item No.	Item No.	Item No.	Item No.	Item No.
WCGW 020101	3,97	1,59	0,10	DP2010-0571	DP1110-1504	TI5010-1571	TI5510-2534	TI5910-2534
WCGW 020102	3,97	1,59	0,20	DP2010-0572	DP1110-1506	TI5010-1572	TI5510-2536	TI5910-2536
WCGW 020104	3,97	1,59	0,40	DP2010-0573	DP1110-1508	TI5010-1573	TI5510-2538	TI5910-2538

### Application range:

- CVD-D Aluminum, Carbide >10%Co, Brass, Brass lead-free, Graphite, Composites (CFRP, GFRP, MMC), Titanium ...
- UltraDia. Acrylic, Ceramics, Carbide <12%Co, Zirconium ...
- CBN-H Steel hardened up to 72 HRC
- CBN-K Grey Cast Iron (GCI), Ductile Cast Iron (DCI) ...
- CBN-X Tool Steel hardened up to 72 HRC, Tool Steel low alloy, Stellite, powder metallurgical Steel ...

## Your Notes

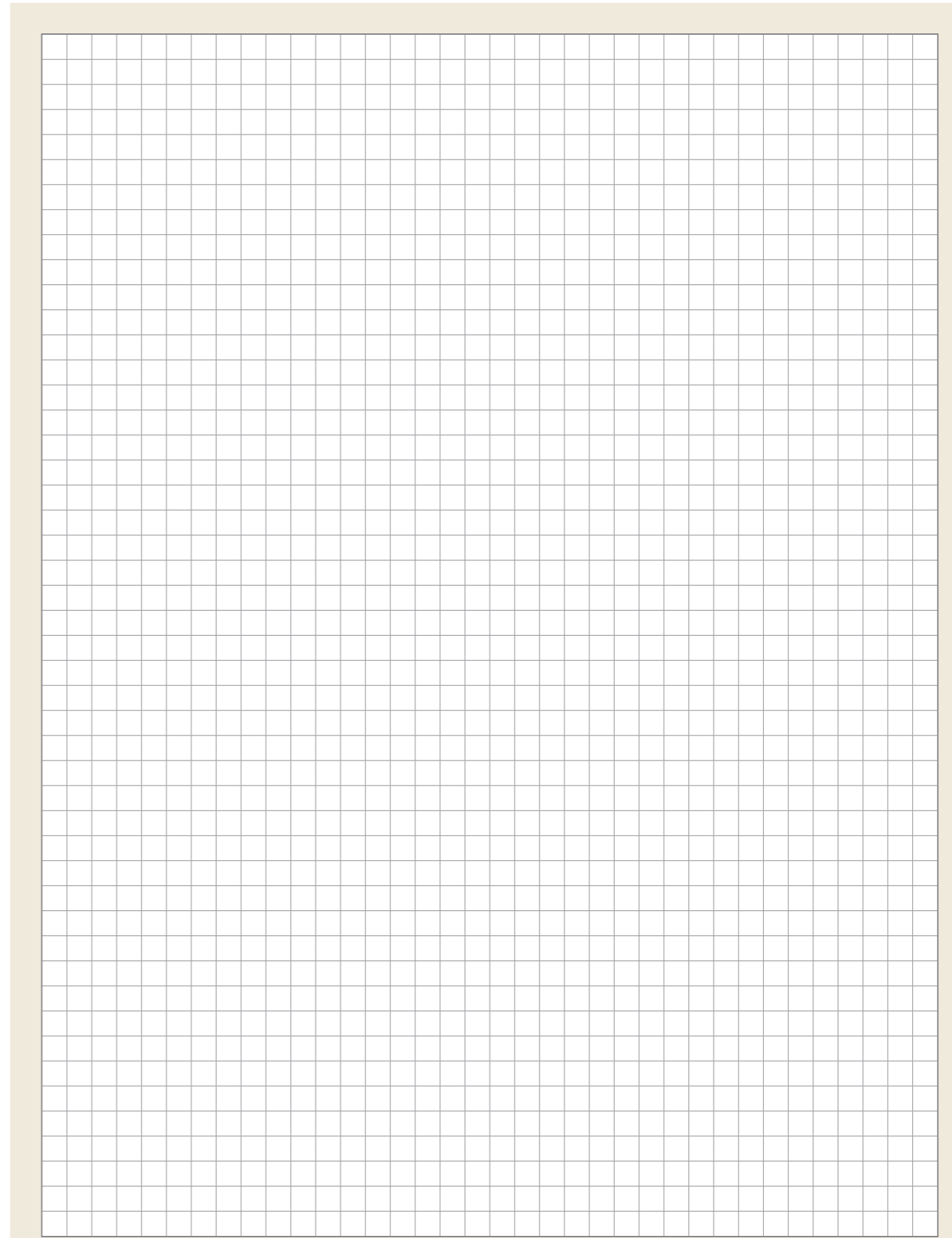

# Clamping Systems

Hydraulic Expansion Chuck

## Take advantage!

- ✓ High damping
- ✓ Tool life increase up to approximately 30%
- ✓ Automatic cutting edge adjustment
- ✓ Excellent surface quality
- ✓ High dimensional stability
- ✓ Easy and quick change of the boring bar

## Functionality

Automatic adjustment of center height through pin, resulting in a very high repeat accuracy

This gives you a very high repeat accuracy.

 Cooling through the clamping surface

### Note

Never clamp the hydraulic expansion mount without the boring bar inserted

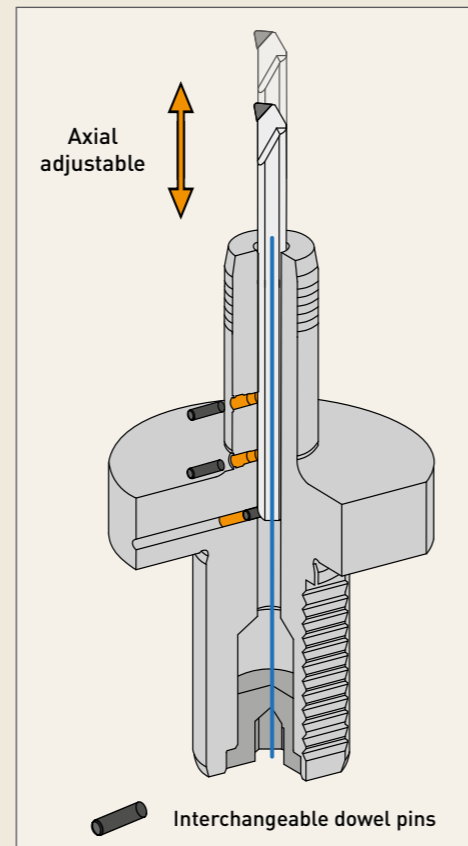

## Adjustment Guide

for tool change

1. Loosen screw 4
2. Insert boring bar
3. Turn tool slightly at stop until resistance is felt
4. Tighten screw 4 with max. 10Nm

-> Tool ready for use

### Extended length too long?

1. Loosen screw 4
2. Remove threaded pin 1 (if necessary 2 also)
3. Remove alignment pin
4. Insert threaded pin 1 (if necessary 2 also)
5. Repeat adjustment guide from point 2

4.) Clamping Screw, max. 10 Nm

1.) Alignment Pin, optional

3.) Alignment Pin, fixed mounted

3.) Alignment Pin, fixed mounted

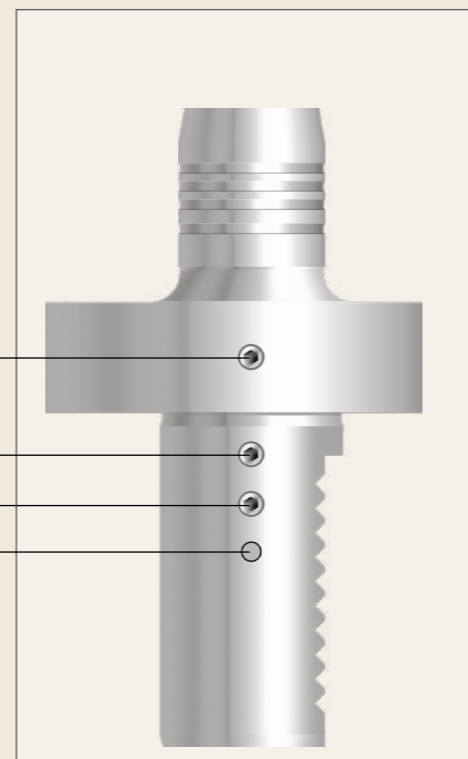

\*Positioning of alignment pins may deviate due to manufacturing process

# Hydraulic Chuck

with VDI-Holder

for brazed boring tools and MiniTools

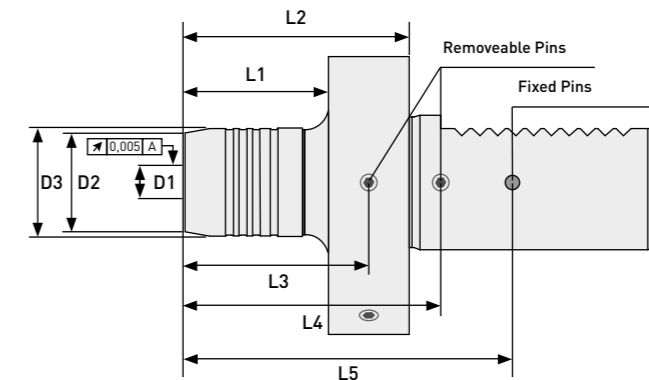

D1	VDI	D2	D3	L1	L2	L3	L4	L5	Item No.
4,00	16	18,00	20,00	33,00	58,00	46,00	54,00	62,00	BA7090-2040
	20	18,00	20,00	32,00	50,00	46,00	54,00	62,00	BA7090-2240
	25	18,00	20,00	32,00	50,00	46,00	54,00	62,00	BA7090-2245
	30	18,00	20,00	32,00	50,00	46,00	54,00	62,00	BA7090-2340
	40	18,00	20,00	58,00	76,00	46,00	54,00	62,00	BA7090-2440
5,00	16	18,00	20,00	51,00	76,00	62,00	72,00	82,00	BA7090-2050
	20	18,00	20,00	48,00	66,00	62,00	72,00	82,00	BA7090-2250
	25	18,00	20,00	48,00	66,00	62,00	72,00	82,00	BA7090-2255
	30	18,00	20,00	38,00	56,00	62,00	72,00	82,00	BA7090-2350
	40	18,00	20,00	56,00	76,00	62,00	72,00	82,00	BA7090-2450
6,00	16	18,00	20,00	45,00	71,00	55,00	67,00	79,00	BA7090-2060
	20	18,00	20,00	42,00	60,00	55,00	67,00	79,00	BA7090-2260
	25	18,00	20,00	42,00	60,00	55,00	67,00	79,00	BA7090-2265
	30	18,00	20,00	42,00	60,00	55,00	67,00	79,00	BA7090-2360
	40	18,00	20,00	58,00	76,00	55,00	67,00	79,00	BA7090-2460
8,00	16	22,00	24,00	37,00	62,00	41,00	57,00	73,00	BA7090-2080
	20	22,00	24,00	35,00	53,00	41,00	57,00	73,00	BA7090-2280
	25	22,00	24,00	34,00	52,00	41,00	57,00	73,00	BA7090-2285
	30	22,00	24,00	32,00	50,00	41,00	57,00	73,00	BA7090-2380
	40	22,00	24,00	60,00	80,00	41,00	57,00	73,00	BA7090-2480
10,00	20	24,00	26,00	87,00	105,00	77,00	97,00	117,00	BA7090-3911
	25	24,00	26,00	72,00	90,00	77,00	97,00	117,00	BA7090-3913
	30	26,00	28,00	32,00	50,00	37,00	57,00	77,00	BA7090-3915
	40	24,00	26,00	65,00	85,00	77,00	97,00	117,00	BA7090-3917

Accessories and spare parts as well as torque wrenches available on request.

# Clamping Systems

Clamping Adapter round or 4-sided

## Take advantage!

- ✓ Excellent surface quality
- ✓ High dimensional stability
- ✓ High repeat accuracy

## Functionality

- ✓ Automatic adjustment of center height through pin and 45° bevel on the tool
- ✓ Safe and stable positioning of the tool due to the 3-point fixing system
- ✓ Defined coolant supply 
- ✓ Adapter with shank tolerance  $\varnothing 16h6$

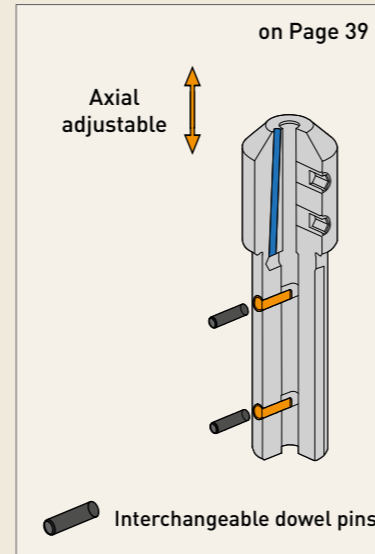

## Functionality

- ✓ Automatic adjustment of center height through pin and 45° bevel on the tool
- ✓ Safe and stable positioning of the tool due to the 3-point fixing system
- ✓ Grinded 4-sided for flexible use in almost all processing machines
- ✓ General coolant supply through clamping surface 
- ✓ Also suitable for use in conventional and NC machines

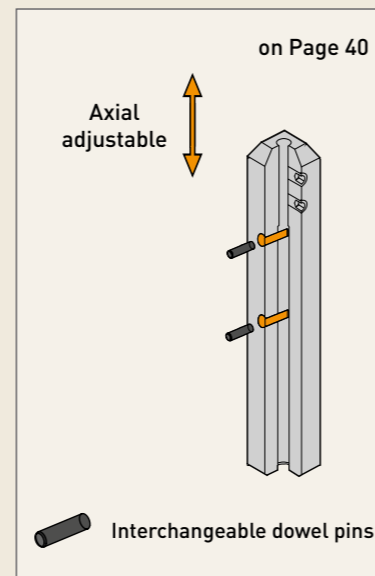

## Functionality

- ✓ Clamping adapter with full-length shank
- ✓ Compatible with standard boring bar holders, D16.0mm
- ✓ Also suitable for use in conventional and NC machines
- ✓ Flexible length adjustment
- ✓ Stable clamping via 3 screws
- ✓ Space-saving and suitable for small machines

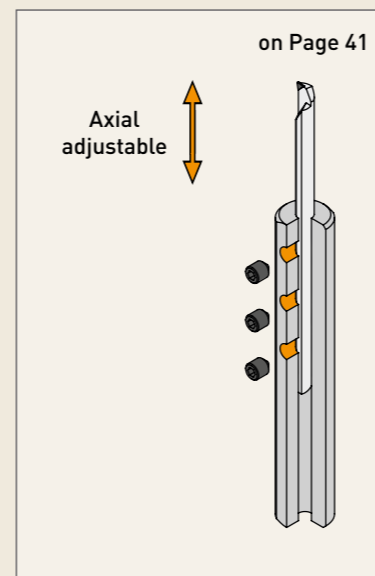

# Clamping Adapter

optional with or without internal cooling

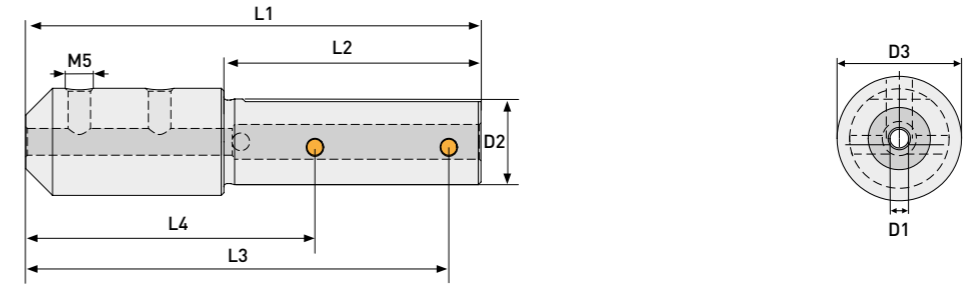

without internal cooling (light cooling through clamping surface)

D1	D2	D3	L1	L2	L3	L4	Item No.
3G6	16h6	20,00	75,00	48,00	64,00	34,00	BA7090-0000
4G6	16h6	20,00	75,00	48,00	64,00	34,00	BA7090-0001
5G6	16h6	20,00	85,00	48,00	79,00	49,00	BA7090-0002
6G6	16h6	20,00	84,00	48,00	78,00	48,00	BA7090-0003
8G6	16h6	20,00	82,00	48,00	77,00	47,00	BA7090-0004

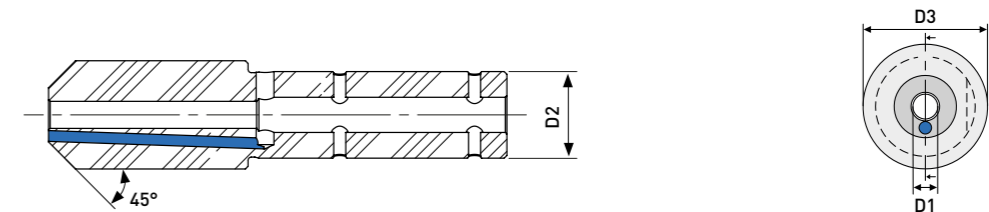

 with internal cooling / Graphic shows right version

D1	D2	D3	L1	L2	L3	L4	Version	Item No.
4G6	16h6	20,00	75,00	48,00	64,00	39,00	right	BA7090-1001
							left	BA7090-2001
5G6	16h6	20,00	85,00	48,00	79,00	54,00	right	BA7090-1002
							left	BA7090-2002
6G6	16h6	20,00	84,00	48,00	78,00	53,00	right	BA7090-1003
							left	BA7090-2003
8G6	16h6	20,00	82,00	48,00	77,00	52,00	right	BA7090-1004
							left	BA7090-2004

Accessories and spare parts as well as torque wrenches available on request.



# Clamping Adapter

4-sided

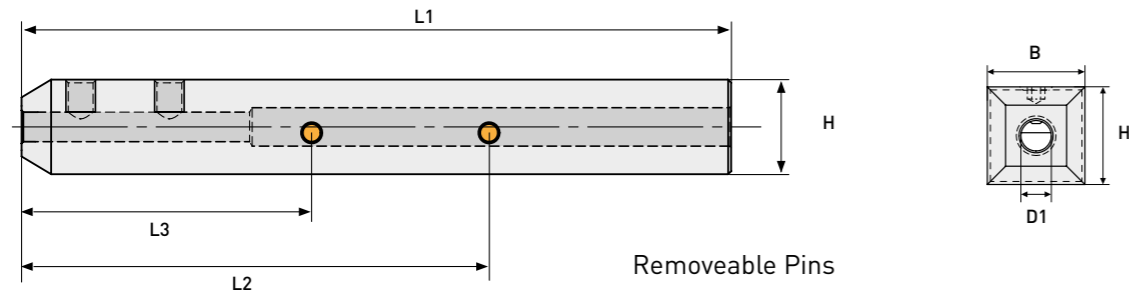

without internal cooling (light cooling through clamping surface)

D1	D2	L1	L2	L3	Item No.
4G6	12x12	120,00	64,06	39,06	BA7090-4040
	16x16	120,00	64,06	39,06	BA7090-4140
	20x20	120,00	64,06	39,06	BA7090-4240
	25x25	120,00	64,06	39,06	BA7090-4340
5G6	12x12	120,00	79,06	49,06	BA7090-4050
	16x16	120,00	79,06	49,06	BA7090-4150
	20x20	120,00	79,06	49,06	BA7090-4250
	25x25	120,00	79,06	49,06	BA7090-4350
6G6	16x16	120,00	78,06	48,06	BA7090-4160
	20x20	120,00	78,06	48,06	BA7090-4260
	25x25	120,00	78,06	48,06	BA7090-4360
8G6	16x16	120,00	77,06	47,06	BA7090-4180
	20x20	120,00	77,06	47,06	BA7090-4280
	25x25	120,00	77,06	47,06	BA7090-4380

Accessories and spare parts as well as torque wrenches available on request.

# Boring bar holders

full-length shaft

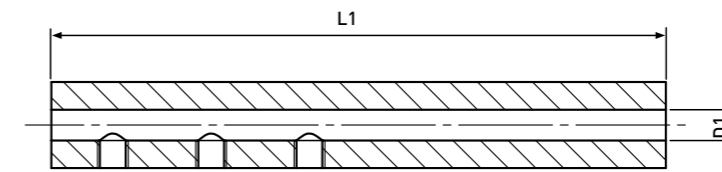
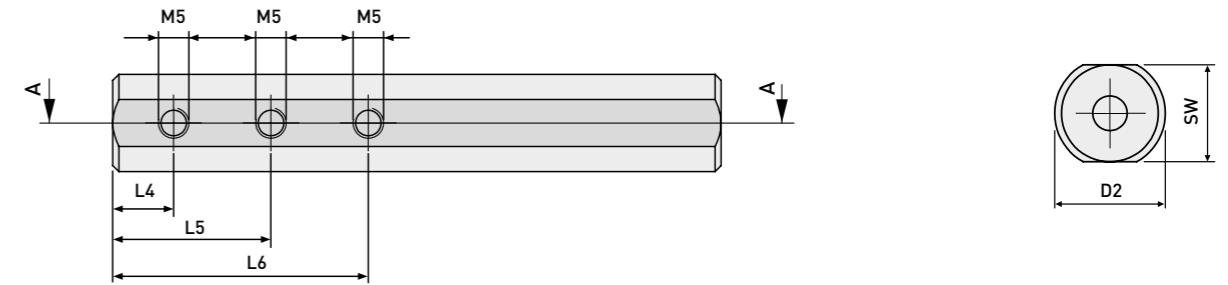

without internal cooling (light cooling through clamping surface)

D1	D2	SW	L1	L4	L5	L6	Item No.
3,00	16h6	14,00	100,00	10,00	26,00	42,00	BA7090-5500
4,00	16h6	14,00	100,00	10,00	26,00	42,00	BA7090-5501
5,00	16h6	14,00	100,00	10,00	26,00	42,00	BA7090-5502
6,00	16h6	14,00	100,00	10,00	26,00	42,00	BA7090-5503
8,00	16h6	14,00	100,00	10,00	26,00	42,00	BA7090-5504

# Cutting Parameters

for our precision boring bars

Material		PCD								
		n [U/min]			a <sub>p</sub> [mm]			F [mm/U]		
		Ø1,0-3,5	Ø4,0-6,0	Ø7,0-10,0	Ø1,0-3,5	Ø4,0-6,0	Ø7,0-10,0	Ø1,0-3,5	Ø4,0-6,0	Ø7,0-10,0
Acryl (PMMA)	min.	5.000	4.500	3.500	0,01	0,01	0,01	0,01	0,01	0,01
	max.	20.000	20.000	20.000	0,05	0,80	2,00	0,05	0,10	0,12
Al Si <10%	min.	5.000	4.000	3.000	0,01	0,01	0,01	0,01	0,01	0,01
	max.	20.000	20.000	20.000	0,30	1,50	2,50	0,05	0,10	0,18
Al Si >10%	min.	5.000	5.000	3.000	0,01	0,01	0,01	0,01	0,01	0,01
	max.	20.000	20.000	20.000	0,20	1,00	2,00	0,05	0,10	0,18
Brass, Brass, bleifrei	min.	5.000	3.000	2.000	0,01	0,01	0,01	0,01	0,01	0,01
	max.	15.000	12.000	10.000	0,10	0,50	2,00	0,05	0,10	0,15
Carbide, Ceramic sintered, Ceramics Green	min.	5.000	4.000	3.500	0,01	0,01	0,01	0,01	0,01	0,01
	max.	15.000	15.000	12.000	0,05	0,50	1,00	0,05	0,10	0,12
CFK	min.	4.000	3.000	2.000	0,01	0,01	0,01	0,01	0,01	0,01
	max.	15.000	15.000	15.000	0,10	0,50	1,00	0,05	0,10	0,15
Copper	min.	3.000	2.500	2.000	0,01	0,01	0,01	0,01	0,01	0,01
	max.	15.000	16.000	12.000	0,10	0,50	2,50	0,05	0,15	0,2
GFK	min.	on request								
	max.	on request								
Gold, Silver, Platinum	min.	4.000	3.500	3.000	0,01	0,01	0,01	0,01	0,01	0,01
	max.	20.000	20.000	20.000	0,10	0,50	1,00	0,05	0,10	0,15
Graphit	min.	4.000	3.500	3.000	0,02	0,01	0,01	0,01	0,01	0,01
	max.	18.000	15.000	15.000	0,10	1,00	2,50	0,05	0,10	0,20
Plastics	min.	4.000	3.500	2.500	0,01	0,01	0,01	0,01	0,01	0,01
	max.	15.000	15.000	15.000	0,30	1,50	2,50	0,05	0,10	0,18
MMC	min.	5.000	3.000	2.000	0,01	0,01	0,01	0,01	0,01	0,01
	max.	15.000	12.000	10.000	0,10	0,50	2,00	0,05	0,10	0,15
Titanium	min.	4.000	3.500	2.000	0,010	0,01	0,01	0,01	0,01	0,01
	max.	10.000	8.000	6.000	0,025	0,05	0,10	0,05	0,06	0,08
Zink	min.	5.000	4.000	3.000	0,01	0,01	0,01	0,01	0,01	0,01
	max.	20.000	20.000	20.000	0,30	1,50	2,50	0,05	0,10	0,2

Material		CVD-D									Cooling				
		n [U/min]			a <sub>p</sub> [mm]			F [mm/U]			Trocken	Luft	Emulsion	Öl	MMS
		Ø1,0-3,5	Ø4,0-6,0	Ø7,0-10,0	Ø1,0-3,5	Ø4,0-6,0	Ø7,0-10,0	Ø1,0-3,5	Ø4,0-6,0	Ø7,0-10,0					
Acryl (PMMA)	min.	4000	3500	2500	0,01	0,01	0,01	0,01	0,01	0,01			2. Choice	1. Choice	
	max.	30000	25000	22000	0,05	0,80	2,00	0,05	0,10	0,12			2. Choice	1. Choice	
Al Si <10%	min.	4500	4000	2000	0,01	0,01	0,01	0,01	0,01	0,01				1. Choice	2. Choice
	max.	30000	30000	30000	0,30	1,50	2,50	0,05	0,10	0,18				1. Choice	2. Choice
Al Si >10%	min.	4500	4000	2000	0,01	0,01	0,01	0,01	0,01	0,01				1. Choice	2. Choice
	max.	30000	30000	30000	0,20	1,00	2,00	0,05	0,10	0,18				1. Choice	2. Choice
Brass, Brass, bleifrei	min.	4000	3000	1000	0,01	0,01	0,01	0,01	0,01	0,01			1. Choice		
	max.	20000	18000	15000	0,10	0,50	2,00	0,05	0,10	0,15			1. Choice		
Carbide, Ceramic sintered, Ceramics Green	min.	4000	3000	1500	0,01	0,01	0,01	0,01	0,01	0,01				1. Choice	
	max.	20000	20000	18000	0,05	0,50	1,00	0,05	0,10	0,12				1. Choice	
CFK	min.	3000	2500	1000	0,01	0,01	0,01	0,01	0,01	0,01				1. Choice	2. Choice
	max.	20000	20000	18000	0,10	0,50	1,00	0,05	0,10	0,15				1. Choice	2. Choice
Copper	min.	2000	1500	1000	0,01	0,01	0,01	0,01	0,01	0,01	1. Choice				
	max.	20000	18000	15000	0,10	0,50	2,50	0,05	0,15	0,20	1. Choice				
GFK	min.	on request									on request				
	max.	on request									on request				
Gold, Silver, Platinum	min.	3000	2500	2000	0,01	0,01	0,01	0,01	0,01	0,01				1. Choice	2. Choice
	max.	30000	25000	20000	0,10	0,50	1,00	0,05	0,10	0,15				1. Choice	2. Choice
Graphit	min.	3000	2500	2000	0,02	0,01	0,01	0,01	0,01	0,01				1. Choice	
	max.	20000	20000	18000	0,10	1,00	2,50	0,05	0,10	0,20				1. Choice	
Plastics	min.	3000	2500	1500	0,01	0,01	0,01	0,01	0,01	0,01				1. Choice	1. Choice
	max.	20000	20000	18000	0,30	1,50	2,50	0,05	0,10	0,18				1. Choice	1. Choice
MMC	min.	4000	3000	1000	0,01	0,01	0,01	0,01	0,01	0,01				1. Choice	
	max.	20000	15000	15000	0,10	0,50	2,00	0,05	0,10	0,15				1. Choice	
Titanium	min.	3500	2000	1200	0,01	0,01	0,01	0,01	0,01	0,01				1. Choice	
	max.	12000	8000	6000	0,025	0,05	0,10	0,05	0,06	0,08				1. Choice	
Zink	min.	4000	3000	2000	0,01	0,01	0,01	0,01	0,01	0,01				1. Choice	2. Choice
	max.	30000	30000	30000	0,30	1,50	2,50	0,05	0,10	0,20				1. Choice	2. Choice

Material		CBN								
		n [U/min]			a <sub>p</sub> [mm]			F [mm/U]		
		Ø1,0-3,5	Ø4,0-6,0	Ø7,0-10,0	Ø1,0-3,5	Ø4,0-6,0	Ø7,0-10,0	Ø1,0-3,5	Ø4,0-6,0	Ø7,0-10,0
Steel hardened to 42 HRC	min.	3.000	3.000	2.000	0,01	0,01	0,01	0,004	0,005	0,005
	max.	12.000	10.000	8.000	0,025	0,20	0,50	0,008	0,08	0,18
Steel hardened to 52 HRC	min.	3.000	3.000	2.000	0,01	0,01	0,01	0,004	0,005	0,005
	max.	12.000	10.000	8.000	0,025	0,20	0,50	0,008	0,08	0,18
Steel hardened to 60 HRC	min.	3.000	2.500	2.000	0,01	0,01	0,01	0,004	0,005	0,005
	max.	10.000	8.000	8.000	0,025	0,20	0,50	0,008	0,10	0,18
Steel hardened to 68 HRC	min.	2.500	2.000	1.500	0,01	0,01	0,01	0,004	0,005	0,005
	max.	8.000	6.000	6.000	0,025	0,15	0,3	0,03	0,12	0,15
Ni-, Co-, Fe- u. Cr-Alloys	min.	2.000	2.000	1.500	0,01	0,01	0,01	0,004	0,005	0,005
	max.	8.000	6.000	6.000	0,025	0,015	0,30	0,03	0,12	0,15
Powder Metallurgical Steels, Hardened Cold and hot Work Steels, hardened	min.	2.000	2.200	2.500	0,02	0,02	0,02	0,01	0,02	0,03
	max.	8.000	6.000	6.000	0,05	0,30	0,40	0,05	0,10	0,20
Tool Steel and HSS, hardened	min.	2.000	1.500	1.000	0,02	0,025	0,025	0,01	0,02	0,03
	max.	8.000	6.000	5.000	0,05	0,30	0,5	0,05	0,10	0,20
Titanium	min.	2.000	1.500	1.000	0,01	0,03	0,05	0,01	0,02	0,03
	max.	10.000	8.000	6.000	0,015	0,15	0,25	0,05	0,06	0,08
Carbide >20%Co	min.	on request								
	max.									
Carbide-Steel Composite	min.	on request								
	max.									

## Cooling recommended

In machining with CBN inserts, proper cooling is a key to successful machining.

Here you will find our recommendation:

When machining interrupted cuts, we recommend dry machining or cooling by air.

Material	Cooling				
	Dry	Air	Emulsion	Oil	MQL
Steel hardened to 42 HRC		3. Choice	1. Choice	2. Choice	
Steel hardened to 52 HRC		3. Choice	1. Choice	2. Choice	
Steel hardened to 60 HRC		3. Choice	1. Choice	2. Choice	
Steel hardened to 68 HRC		3. Choice	1. Choice	2. Choice	
Ni-, Co-, Fe- u. Cr-Alloys		3. Choice	1. Choice	2. Choice	
Powder Metallurgical Steels, Hardened Cold and hot Work Steels, hardened		3. Choice	1. Choice	2. Choice	
Tool Steel and HSS, hardened		3. Choice	1. Choice		2. Choice
Titanium			1. Choice		2. Choice
Carbide >20%Co	on request				
Carbide-Steel Composite					



If you have any further technical questions, please do not hesitate to contact us  
by phone or e-mail!

Phone: +49(0)6301 32011-0

Mail: [info@diamond-toolingsystems.com](mailto:info@diamond-toolingsystems.com)

# Formulas

Turning

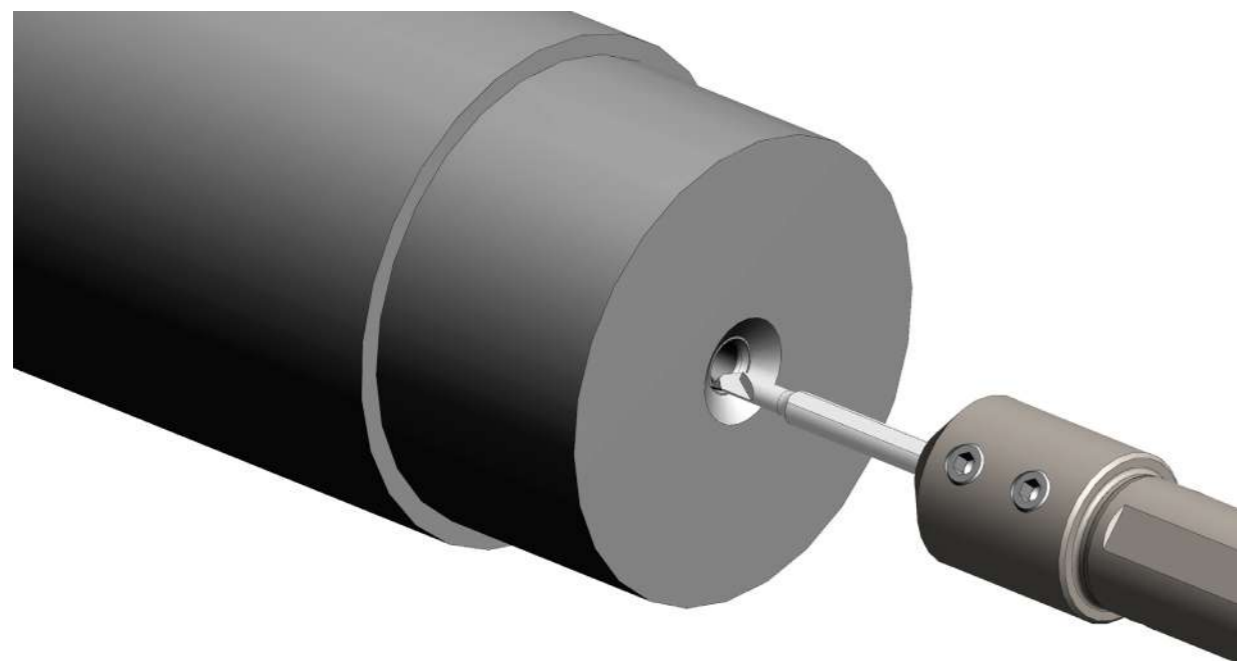

$V_f$	Feed rate	mm/min
$f_n$	Feed per revolution	mm/rev
$n$	Spindle speed	rev/min
$v_c$	Cutting speed	m/min
$D_c$	Cutter diameter	mm
$t_c$	Cutting Time	min
$l_m$	Cutting length	mm
$Q$	Stock removal rate	cm <sup>3</sup> /min
$a_p$	Cutting depth	mm

## ▶ Cutting speed

$$V_c = \frac{D_c \times \pi \times n}{1000} \quad [\text{m/min}]$$

## ▶ Spindle speed

$$n = \frac{v_c \times 1000}{\pi \times D_c} \quad [\text{U/min}]$$

## ▶ Feed per revolution

$$f_n = \frac{V_f}{n} \quad [\text{mm/U}]$$

## ▶ Cutting time

$$t_c = \frac{l_m}{f_n \times n} \quad [\text{min}]$$

## ▶ Stock removal rate

$$Q = v_c \times a_p \times f_n \quad [\text{cm}^3/\text{min}]$$

# Your Notes

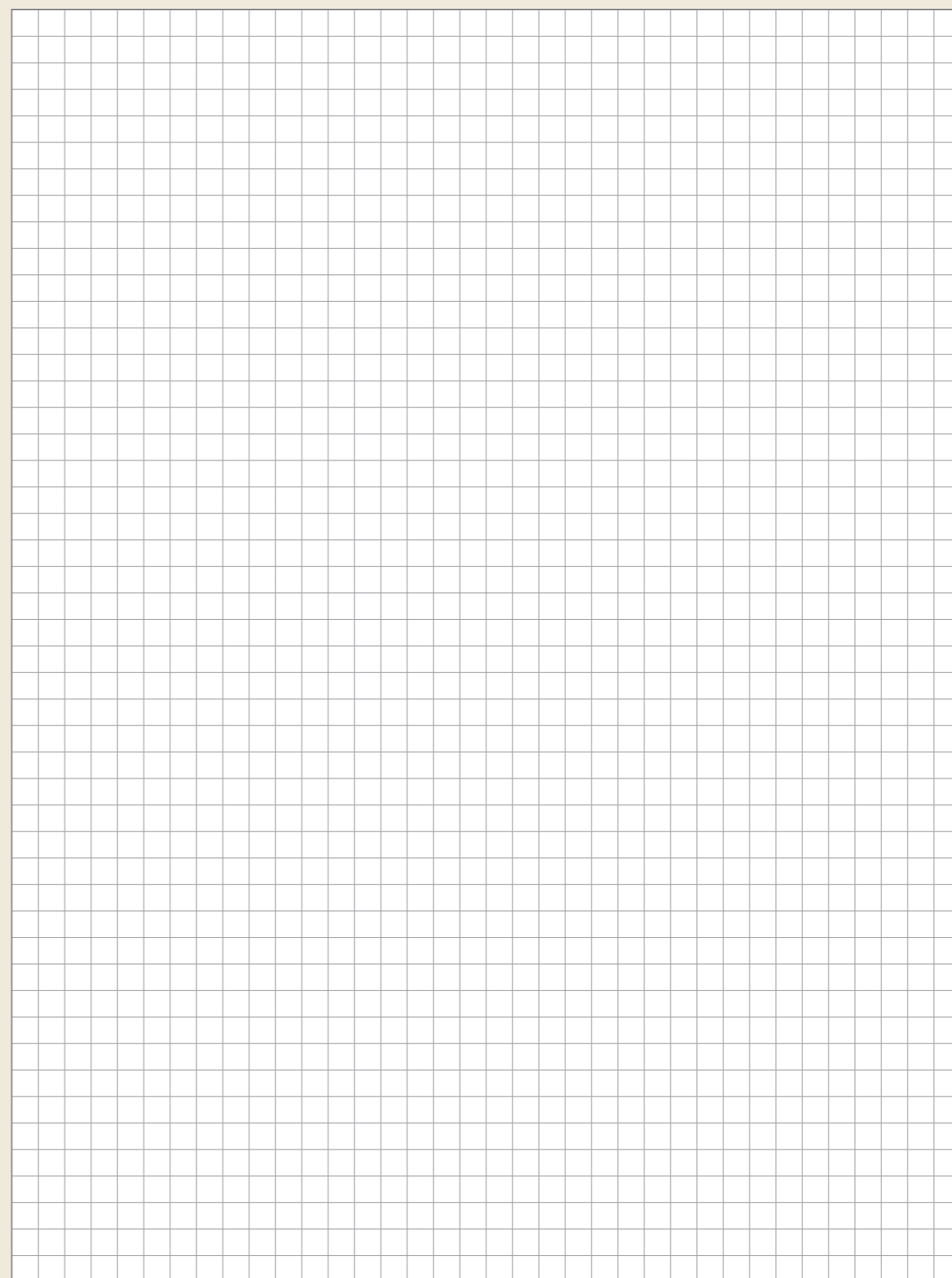

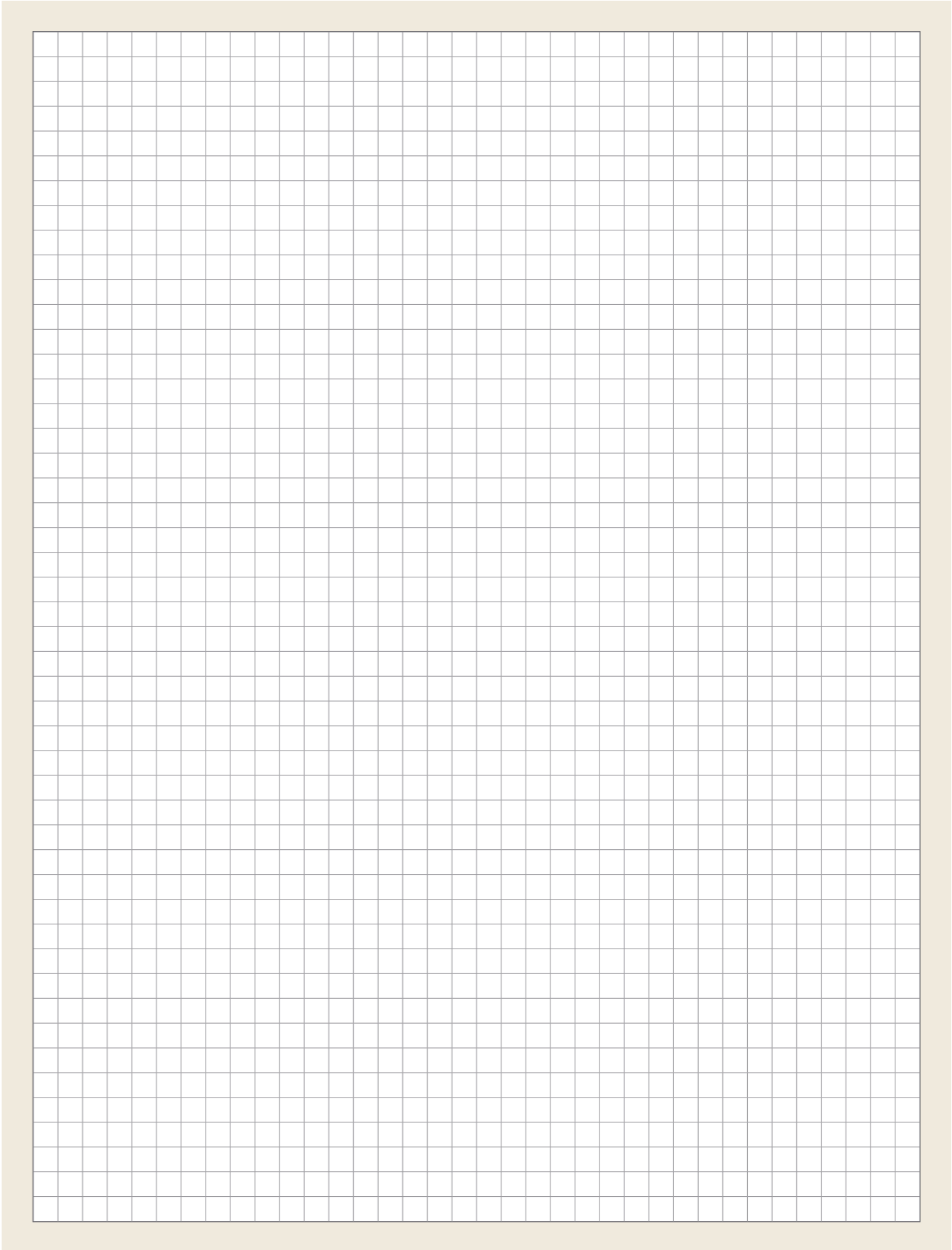
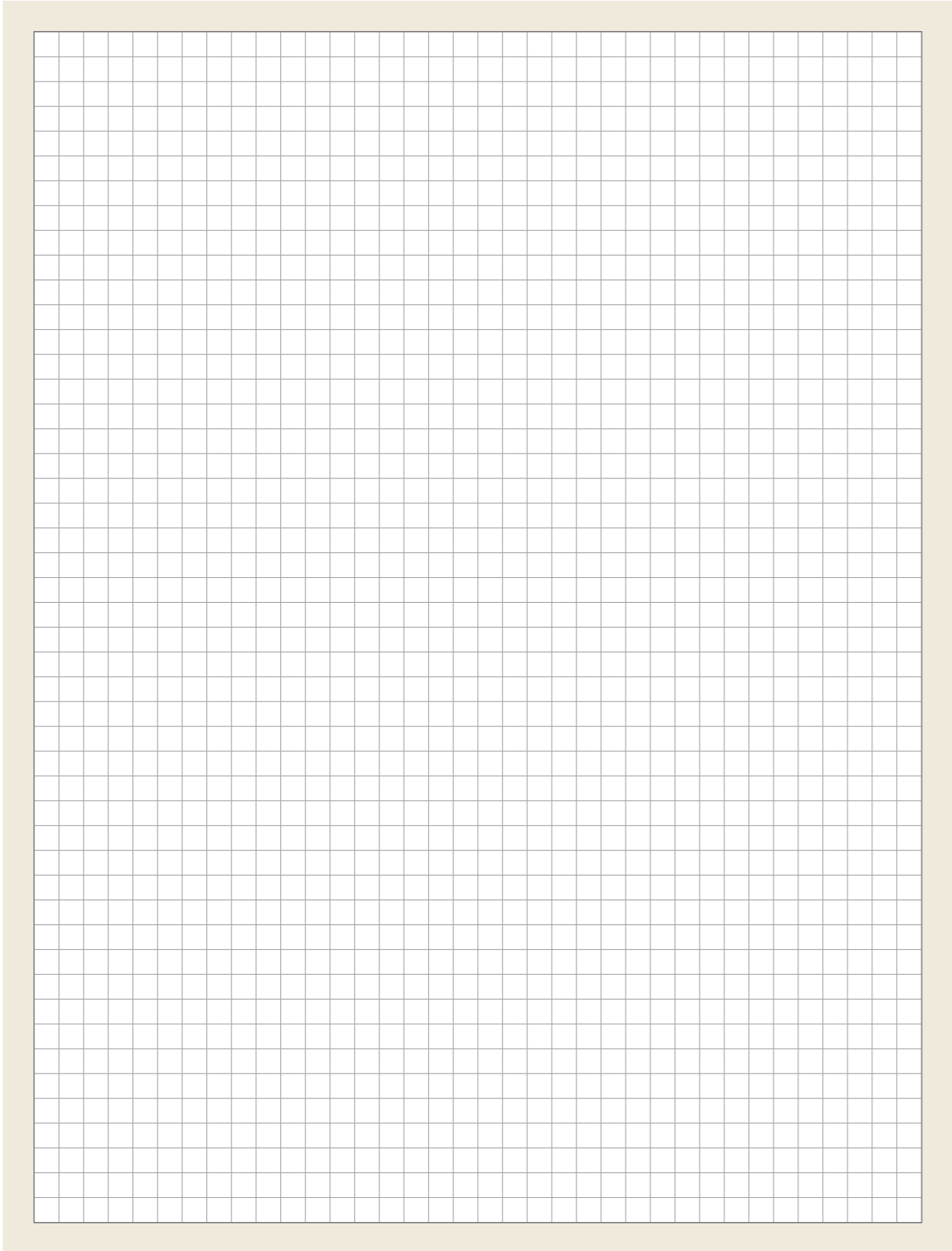



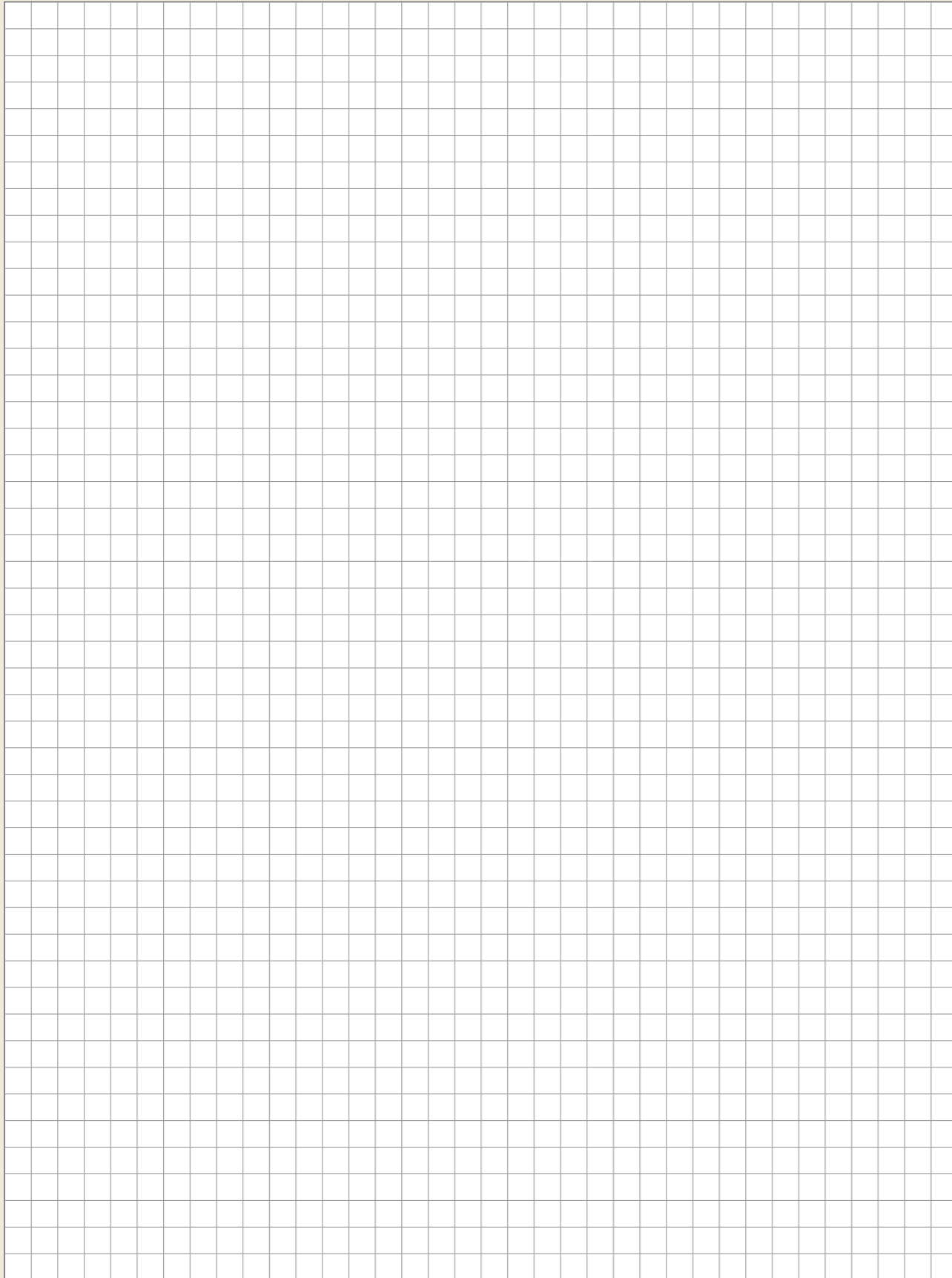

### Copyright:

The reprint of our catalogs, copies of our flyers and newsletters or only excerpts such as illustrations, designs, technical information and design require the written permission of DTS GmbH. Copies or only excerpts such as illustrations, designs, technical information from our homepage and our online store are only permitted with the written consent of DTS GmbH.

All rights are reserved. Errors, misprints or printing errors do not entitle to claims. The pictorial and graphic representation of our tools do not necessarily have to correspond to the actual tool in all details.

We reserve the right to make production-related technical changes and changes to the delivery program. The cutting values given are guide values which must be adjusted according to the process environment.

### Safety Instructions:

- ▶ DTS tools equipped with ultra-hard cutting edges are very sharp laser cut tools.
- ▶ Careful handling of the tools during unpacking and their use is recommended.
- ▶ Wearing protective gloves reduces the risk of injury.
- ▶ Material chipping and tool breakage may occur during machining, wearing safety glasses is recommended.
- ▶ Balanced holders are recommended for speeds above 10,000 rpm.
- ▶ We do not accept any responsibility for tools that have been modified, reground or used incorrectly and beyond their normal service life.
- ▶ Protective goggles are recommended when using DTS tools, sparks may also occur, make sure that no fire can occur.

Diamond Tooling Systems



**DTS GmbH**



Instagram



YouTube



LinkedIn



DTS Shop



DTS Website



**PASSION FOR DIAMOND**

Hans-Geiger-Straße 11a · D-67661 Kaiserslautern

+49 (0) 6301 32011-0

+49 (0) 6301 32011-90

[info@diamond-toolingsystems.com](mailto:info@diamond-toolingsystems.com)

Homepage: [www.diamond-toolingsystems.com](http://www.diamond-toolingsystems.com)

Shop: [www.diamond-tools24.com](http://www.diamond-tools24.com)